



FireLine Data Radio Modem Technical Manual

*Version E4
March 2007*



Raveon Technologies Corporation
2780 La Mirada Drive, Suite C
Vista, CA 92081
www.raveontech.com

Table of Contents

1.	General Information about the FireLine.....	3
2.	Overview	6
3.	Specifications	7
4.	Electrical Inputs and Outputs	9
5.	Using the FireLine Modem – Packet Mode	15
6.	Installation.....	30
7.	FCC Licensing Information.....	30
8.	User Serial Port Commands	32
9.	FireLine Diagnostic Provisions.....	42
10.	Tune-up and Alignment	46
11.	SkyLine Compatibility	50
12.	Antenna Information	52
13.	Internal Radio Connection	53
14.	Appendix A. Serial Port Hardware	54
15.	Troubleshooting.....	58
16.	Mechanical	60
17.	Use with External Radio	61

1. General Information about the FireLine

1.1. Congratulations!

Congratulations on your purchase of a *FireLine* radio modem.

Please take a few minutes to read this manual carefully. The information presented here will allow you to derive maximum performance from your radio modem. After reading it, keep the manual handy for quick reference, in case questions arise later on.

1.2. NOTICE

There are no user-serviceable points inside this transceiver. All service work must be referred to your Authorized Service Center or Raveon Technologies Service Department.

1.3. Safety / Warning Information

WARNING - DO NOT operate the RV-M5-U radio modem when bystanders are within 2 feet (.6 meters) of the antenna.

Blasting Caps and Blasting Areas

To avoid possible interference with blasting operations, turn off this radio or remove the DC power when you are near electrical blasting caps, in a blasting area, or in areas posted: "**Turn off two-way radio.**" Obey all signs and instructions.

Potentially Explosive Atmospheres

Turn off your radio prior to entering any area with a potentially explosive atmosphere. Do not install this product for use in areas with potentially explosive atmospheres. Do not remove, install, or charge batteries in such areas. Sparks in a potentially explosive atmosphere can cause an explosion or fire resulting in bodily injury or even death.

Note: The areas with potentially explosive atmospheres referred to above include fueling areas such as below decks on boats, fuel or chemical transfer or storage facilities, areas where the air contains chemicals or particles, such as grain, dust or metal powders, and any other area where you would normally be advised to turn off your vehicle engine. Areas with potentially explosive atmospheres are often but not always posted.

1.4. Safety Training information:

Antennas used for this transmitter must not exceed an antenna gain of 0 dBd. The radio modem must be used in fixed vehicle-mount configurations or at fixed base-station sites. It is not intended for portable applications.

This radio is restricted to occupational use, work related operations only where the radio operator must have the knowledge to control the exposure conditions of its passengers and bystanders by maintaining the minimum

separation distance of following range. Failure to observe these restrictions may result in exceeding the FCC RF exposure limits.

Antenna Installation:

For rear deck trunk installation, the antenna must be located at least the following range away from rear seat passengers and bystanders in order to comply with the FCC RF exposure requirements.

For model **RV-M5-UC**:

<p>Radiated frequency and Distance RV-M5-UC (406-512MHz 2 watts) 1.97 Feet (0.6 m) FCC ID: SRS-RV-M5-UC Raveon Technologies Corporation</p>

For Model **RV-M5-VB**:

<p>Radiated frequency and Distance RV-M5-VB (150-174MHz 2 watts) 1.97 Feet (0.6 m) FCC ID: SRS-RV-M5-VB Raveon Technologies Corporation</p>

For vehicular roof top installation, the antenna must be placed in the center of the roof.

1.5. FCC Compliance Information

This device complies with part 15 of the FCC Rules. Operation is subject to the following two conditions: (1) This device may not cause harmful interference, and (2) this device must accept any interference received, including interference that may cause undesired operation.

Changes or modifications not expressly approved by the party responsible for compliance could void the user's authority to operate the equipment.

NOTE: The manufacturer is not responsible for any radio or TV interference caused by unauthorized modifications to this equipment. Such modifications could void the user's authority to operate the equipment.

This product also complies with FCC Part 22, 90 and Part 95 Subpart J of the FCC rules and regulations.

The Federal Communications Commission (FCC), with its action in ET Docket 93-62, has adopted a safety standard for human exposure to Radio Frequency (RF) electromagnetic energy emitted by FCC-certified equipment. This product meets the uncontrolled environmental limits as stated in OET-65C (01-01) when operated in accordance with the operation guidelines described in this manual. Proper operation of this radio device according to the instructions in this publication will result in user exposure substantially below the FCC recommended limits.

This equipment generates, uses, and radiates radio frequency energy, and if not installed and used in accordance with the instructions, may cause harmful interference. However, there is no guarantee that interference will not occur. If this equipment does cause interference to radio or television reception, which can be determined by turning the equipment off and on, the user is encouraged to correct the interference by one of the following measures:

- Reorient or relocate the receiving antenna.
- Increase separation between the equipment and receiver.
- Connect the equipment to an outlet on a circuit different from which the receiver is connected.
- Consult the dealer or an experienced radio/TV technician.

2. Overview

The *FireLine* RF data radio is a rugged high-performance, high-speed narrow-band data modem. It contains a receiver, a transmitter, and modem, creating an easy-to-use transparent data radio link. The *FireLine's* user interface is asynchronous RS-232 data into and out of the *FireLine* (CMOS level optional). Modem operation is virtually transparent to the user and the configuration of the modem is via the user serial port.

Unlike any other radio modem on the market, the *FireLine* may be operated in either a "*Packetized Mode*" or a "*Streaming Real-Time Mode*". There are advantages to each approach, and your choice depends upon how your system operates.

For privacy and network versatility, the *FireLine* incorporates a 16 bit identification code. Its protocol also uses a 16bit CRC to guarantee the integrity of the data. Perfect for SCADA and telemetry applications, the *FireLine* can be used for simple point-to-point data communication applications, or for more sophisticated point-to-multipoint, peer-to-peer, or mesh networks.

Although the *FireLine* is the easiest to use modem on the market, its re-programmability makes it extremely versatile. Most parameters within the modem may be re-configured to optimize it for specialized operations, extended range, or higher data throughput.

2.1. Features

- *High-speed over the air data rates. 19200bps in 25kHz channel, 9600bps in 12.5kHz.*
- *Built-in radio transceiver with integrated modem*
- *Easy to use. Plug-in, Turn-on, and GO. Transmit data in = Receive data out.*
- *Lowest current draw in industry.*
- *Wide input voltage with high-efficiency switching voltage regulator.*
- *Integrated Packet data protocol and built-in Streaming Real-Time operation.*
- *ARQ error correction and retransmission capability. Totally transparent to the application.*
- *Capable of store-and-forward repeating operation.*
- *Small sized and very rugged extruded enclosure.*
- *16 bit addressing for up to 65,525 different unique device addresses per channel*
- *Supports group and broadcast transmissions. Network mask allows groups of any size.*
- *2 watts of RF output. Other RF power levels available upon request.*
- *Easily configured using "AT" commands*
- *Very fast Transmit-to-Receive turn around time.*
- *RS-232 serial input and output. Programmable serial baud rates up to 57600.*
- *Programmable over-the-air data rates for long-range or high-speed*
- *Automatic key of transmitter on data.*
- *RF carrier-detect is not required receiving. No squelch setting required.*
- *SkyLine compatibility mode for use in older Sonik radio systems.*

3. Specifications

3.1. General

All measurements made per TIA-603-B

Frequency:	Model RV-M5-VA (Export only).....	136 - 150MHz
	Model RV-M5-VB.....	148 - 174MHz
	Model RV-M5-UC.....	450 – 480MHz
	Model RV-M5-UA (export only).....	403 – 434MHz
	Model RV-M5-X.....	For use with external radio
Size (2w inches).....		3.0D X 3.76W X 1.40H
(5w INCHES).....		3.6D X 3.76W X 1.40H
DC input voltage.....		9-16V DC
Typical current draw, receiving, over-the-air rates < 4800bps.....		<80mA
Typical current draw, receiving, over-the-air rates >= 4800bps.....		<110mA
Typical current draw, receiving, Ethernet Option installed.....		<300mA
Current draw when transmitting data.....		<1.7A max, 1.5A typical at 2watts
		<2.2A at 5watts
Low Power Mode standby current.....		<40mA
Frequency stability.....		±1.5ppm
Over-the-air baud rates (programmable).....		800, 1200, 2400, 4800, 5142, 8000, 9600, 19200
Internal data buffers (transmit and receive).....		>2000 bytes
Operating temperature range.....		-30°C to +60°C (-30°C to +80°C storage)
TX-RX and RX-TX turn-around time.....		<10mS
Power on time to operational.....		<500mS
LPM Standby to operational.....		<25mS
FCC ID	Model RV-M5-UC.....	SRS-RV-M5-UC
	Model RV-M5-VB.....	SRS-RV-M5-VB
	All other models for export or OEM use	

3.2. Transmitter

Maximum RF power output.....		2.0 watts, 5 watts optional
Maximum duty cycle.....		20% at full power
Maximum transmit frequency deviation.....		± 2.25kHz
Occupied bandwidth 11 kHz (12.5kHz channels)		
		16kHz (25kHz channels)
TX spurious outputs.....		< -70dBc
Emissions designator.....		11K0F1D (12.5kHz channels)
		16K0F1D (25kHz channels)

3.3. Receiver

Typical RX sensitivity (1% BER)		
19200bps, 4-level, 25kHz channel.....		-108dBm
9600bps, 4-level, 12.5kHz channel.....		-109dBm
4800bps, 2-level.....		-113dBm
2400bps.....		-116dBm
1200 and 800bps.....		-118dBm
RX selectivity.....		-50dB (12.5kHz channel spacing)
		-60dB (25kHz channel spacing)

Spurious and image rejection.....-60dB
 RX intermodulation rejection -60dB at 2400bps
 Conducted spurious emissions <-20dBm

3.4. User Input and Output Signals

Serial port baud rates 1200, 2400, 4800, 9600, 19200, 38400, 57600
 Voltage levels RS-232 complaint levels
 Modem handshake signals..... RTS, CTS, DTR, DSR, CD
 RF I/O 50 ohm BNC
 Power B+ input and Ground

3.5. Model Numbers

The model number of the *FireLine* modem identifies its operating frequency band, rf power level, and bandwidth. The models are:

RV-M5-ab-cd where:

- a* = The band (V=136-174MHz, U=406-512MHz)
- b* = Sub band (A,B,C,...)
- c* = Channel Spacing (N=12.5kHz, W=25kHz, S=25kHz SkyLine compatible)
- d* = Power output (2=2 watts, 5=5 watts, 1=500mW)

Other frequency bands, power levels, and channel spacings are available. Contact the factory for your specific needs.

Sub-Bands

Sub-Band Letter	VHF (RV-M5-V...)	UHF (RV-M5-U...)
A	132-150MHz	403-434MHz
B	150-174MHz	435-451MHz
C		450-480MHz

4. Electrical Inputs and Outputs

The front panel of the *FireLine* modem has these features:

1. RF connector
2. Transmit LED (TX)
3. Receive LED (RX)
4. Power LED (PWR)
5. 9-Pin Serial I/O connector
6. DC Power Jack

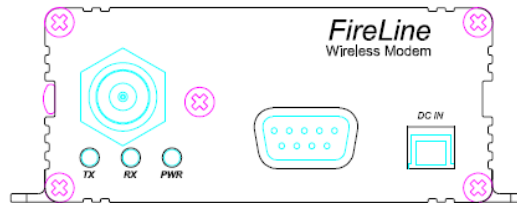

4.1. LEDs

The three status LEDs visually show the current status of the radio.

Transmit LED (TX) This LED blinks red when the transmitter keys and is putting out RF power.

Receive LED (RX) This LED glows red when there is an RF signal on the radio's receive frequency. This LED will indicate the presence of any signal, even one from other sources or radios, data, or voice. If it glows steadily at all times, there is probably some other user on the radio channel. The RF threshold level where this LED illuminates is programmable.

Power LED (PWR) This LED does a short blink, once every two seconds, indicating to the user that the power to the modem is ON and the modem is working. When the modem is in the command mode, this LED will blink on and off, once per second. In the normal operating mode, this led will also blink red with each reception when *FireLine* data is received over the air.

4.2. DC Power

DC power for the modem is connected to the 2-pin DC power input jack labeled **DC IN**. Use the supplied cable to connect the DC power. The **red wire is positive (+)** and the **black wire is negative (-)**. Its connection is optional, as the user may alternately apply power to Pin 9 and ground to pin 5 of the 9-pin I/O connector.

The *FireLine* modem is supplied with a DC power cable, Raveon part number 4C660. The connector housing on the DC power cable is a MOLEX 50-57-9402. The pins used in the housing are MOLEX 16-02-1125. The crimp tool for the connector pins is a Molex part number 11-01-0209.

4.3. RS232/EIA232 Serial I/O Connector

The RS232 9-pin serial I/O connector is a female 9-pin D-subminiature connector having the following pins configuration. It is pinned out so that it may be plugged directly into a computer or PC's 9-pin COM port.

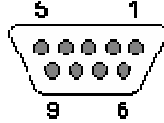

Front-view of DB-9 connector on modem (female)

Pin #	Name	Dir	Function	Level / Specification
1	CD	out	Carrier detect	If enabled, indicates presence of carrier. 0 means carrier is present. If disabled, it is asserted (0) whenever the modem is operational, and not in the configuration mode. It will be a 1 when the modem is in the configuration mode.
2	RxD	out	Receive data	Data out of the modem.
3	TxD	in	Transmit data	Data into the modem.
4	DTR	in	Data terminal ready	Normally ignored by the <i>FireLine</i> modem.
5	GND		Ground connection	Signal and power ground
6	DSR	out	Data Set Ready	Normally is set to 0 when modem is powered on.
7	RTS	in	Request to send	Used to stop/start the flow of data coming out of the modem TxD pin. 0 = OK to send, 1 = don't send. Leave disconnected if not used.
8	CTS	out	Clear to send	Used to stop the flow of data going into the RxD pin from the device connected to the <i>FireLine</i> . 0 = OK to send, 1 = don't send. If the <i>FireLine</i> cannot accept more data, it will negate this signal (set to a 1).
9	Power	In/out	DC power (not Ring signal)	User may supply the DC power to the modem on this pin.

Note: RS-232 signals use positive and negative voltages to represent digital 1s and 0s. A positive voltage is a 0, and a negative voltage is a digital 1.

This pin-out allows it to be directly plugged into a computer's 9-pin serial port using a conventional 9-pin RS-232 serial cable. To connect it to a modem, or computer peripheral that has a serial port, you will need a "null-modem" cable. See Appendix A for more information on wiring a null-modem cable.

To configure the *FireLine* modem for RS-232 operation, use the **ATIO 0** command. RS-232 is the default operation mode for the connector. RS-485 is a factor option. See the next section for details on the RS-485 option.

4.4. EIA-485/RS-485 Serial I/O (Optional)

RS-485 Connector Pin Out

With the RS-485 option installed, the 9-pin serial I/O connector on the front of the FireLine is a female 9-p D-subminiature connector having the following pins configuration.

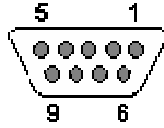

Front-view of DB-9 connector on modem (female)

Pin #	Name	Dir	Function	Level / Specification
1		-	Do not connect	Do not connect this pin to anything.
2		-	Do not connect	Do not connect this pin to anything.
3	B (-)	I/O	B	Inverting RS-485 line
4	A (+)	I/O	A	Non-inverting RS-485 line
5	GND		Ground	Connect to earth ground.
6		-	Do not connect	Do not connect this pin to anything.
7	Out +	out	Do not connect	Internal connection to pin 4
8	In -	in	Do not connect	Internal connection to pin 3
9	Vin	In/Out	DC Power	DC Power in or out if unit is powered using DC in jack.

The RS485 differential line consists of two pins, A and B.

A TxD-/RxD- aka inverting pin which is negative (compared to B) when the line is idle.

B TxD+/RxD+ aka non-inverting pin which is positive (compared to A) when the line is idle.

Configuring

To configure the *FireLine* modem for RS-485 operation, use the **ATIO x** command. **ATIO 2** sets the serial port for standard RS-485, full duplex. **ATIO 3** sets the serial port for RS-485 simplex mode. In most cases, simplex is preferred (**ATIO 3**). In simplex RS-485 mode, the *FireLine*'s serial data receiver is internally disabled whenever it sends a character out the serial port, so that it will not receive its own data. You must order the RS-485 option for this to work, and only modems with Revision E or higher hardware can work in RS-485 mode. For most application use the RS485 simplex mode, ATIO 3. If you are using two *FireLine* modems with RS485 on both units, you must use the simplex RS485 mode instead of the duplex RS485 mode, or the modems will enter an infinite loop-back condition.

Raveon's RS-485 I/O circuit uses 3.3V logic to drive the lines, and the RS485 pins are ESD protected to $\pm 15\text{kV}$ and 7kV human body model. Input current is less than 150uA. Output current when not driving the line is less than 50uA.

Bias and Termination Resistors

RS-485 installations typically have a termination resistor across the A and B lines. For low-speed operation (<57600 baud), this resistor is probably not necessary. If you wish to use a terminating resistor, a value of 150 ohms should work in most applications.

These A/B pin names are all in use on various types of equipment. The RS485 signaling specification states that signal A is the inverting or '-' pin and signal B is the non-inverting or '+' pin. The same naming is specified in the NMEA standards.

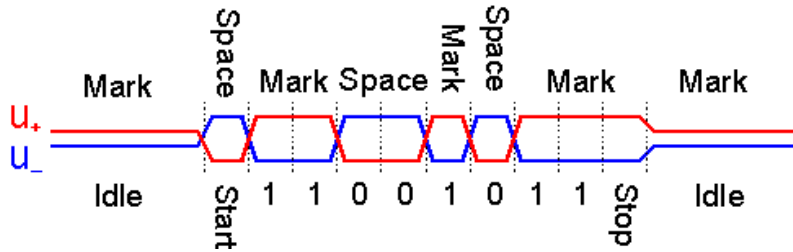

When an RS-485 network is in an idle state, all nodes are in listen (receive) mode. Under this condition there are no active drivers on the network. All drivers are tri-stated. Without anything driving the network, the state of the A and B line is unknown. If the voltage level at the receiver's A and B inputs is less than $\pm 200\text{mV}$ the logic level at the output of the receivers will be the value of the last bit received. In order to maintain the proper idle voltage state, bias resistors must be applied to force the data lines to the idle condition.

FireLine RS-485 receivers have built-in bias resistors, offering the network a true "1/8 unit load". In most allocations, these internal bias resistors are sufficient, and an external bias resistor is not required.

4.5. RS422/EIA-422 Serial I/O Connector (Optional)

The RS422 9-pin serial I/O connector is a female 9-p D-subminiature connector having the following pins configuration.

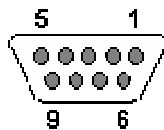

Front-view of DB-9 connector on modem (female)

Pin #	Name	Dir	Function	Level / Specification
1	NC	-	Do not connect	Do not connect this pin.
2	NC	-	Do not connect	Do not connect this pin.
3	OUT -	out	TX out -	0, 3.3V. Inverted version of pin 7.
4	IN +	in	RX input +	
5	GND		Ground	Connect to earth ground.
6	NC	-	Do not connect	Do not connect this pin.
7	Out +	out	TX out +	3.3, 0V.

8	In -	in	RX input -	
9	Vin	In/Out	DC Power	DC Power in or out if unit is powered using DC in jack.

Configuring for RS-422

To configure the *FireLine* modem for RS-422 operation, use the **ATIO 4** command. You must order the RS-422 option for this to work, and only *FireLine* modems with Revision E or higher hardware will work in RS-422 mode. The *FireLine*'s hardware is identical to the RS-485 version, with the exception of two internal loop-back resistors.

Raveon's RS-422 I/O circuit uses 3.3V logic to drive the lines, and the RS422 pins are ESD protected to $\pm 15\text{kV}$ and 7kV human body model.

RS-422 installations typically have a termination resistor across the In and the Out lines. A value of 150 ohms should work in most applications.

Bias and Termination Resistors

FireLine RS-422 receivers have built-in bias resistors, offering the network a true "1/8 unit load". In most allocations, these internal bias resistors are sufficient, and an external bias resistor is not required.

Serial out data comes out pins 3 and 7. Serial input data comes in via pins 4 and 8. Connect pin 5 to earth ground.

FireLine RS-422 receivers have built-in bias resistors, offering the network a true "1/8 unit load". In most allocations, these internal bias resistors are sufficient, and an external bias resistor is not required.

4.6. Low Power Mode (LPM)

The *FireLine* modem (with Revision E firmware and higher), has the ability to be put into a low power mode (LPM). In LPM the modem draws much less current from the DC input. In LPM, the internal radio in the *FireLine* is disabled, as well as certain current-consuming hardware circuits. The ability of the *FireLine* to go into LPM is set with a configuration bit, using the **ATRP 1** command. **ATRP 1** configures the *FireLine* to monitor the DTR input line, and enter the LPM mode whenever DTR is negated. If the DTR signal is asserted, the *FireLine* modem will operate normally.

The *FireLine* can switch between LPM and normal mode using the DTR line, and it switches much faster than using the DC power supply. The *FireLine* takes about $\frac{1}{2}$ of a second to power on when DC is applied, but can switch between normal and LPM in about 25milliseconds.

The factory default value for the **ATRP** setting is **0**. When **ATRP** is a zero, the *FireLine* will not ever enter the LPM mode, and the DTR input signal is ignored.

DTR negated means it is a negative voltage. A voltage less than zero volts applied to DTR will turn the *FireLine* off by putting it into LPM.

To assert the DTR signal (turn the modem on), the DTR line must be high (> 3V). DTR is an input to an RS-232 transceiver IC. It is ESD protected, and is safe for voltages from -20V to +20V input.

5. Using the FireLine Modem – Packet Mode

This section describes the operation of the when it is in the *Packet Mode* of operation. Packet Mode is the factory-default operating mode. It is the easiest and most reliable mode of operation for a modem. Note: The configuration of the *FireLine* is done when the *FireLine* is in the “Command Mode”. Refer to Section 8 on page 32 for details on all of the available commands and programmable features.

In Packet Mode, all transmissions are sent in bursts or packets, and contain address, error detection, and error correction information. Data enters the FireLine modem’s serial I/O port, and is stored in a buffer within the modem until it is ready to be transmitted. Packetized operation has these advantages over non-packet modems:

Packet Mode Advantages

1. ***Error Detection*** The modem uses a 16-bit CRC at the end of every packet of data. The CRC is used to check the data for errors, and if there are any errors, the data will not be passed onto the user.
2. ***Error Correction*** Automatic error correction may be used. *FireLine* modems incorporate an optional ARQ method to re-transmit packets with error, to ensure the user’s data is delivered error-free.
3. ***Addressing*** Packetized operation allows for a more versatile network architecture, with source, destination, and network addresses. FireLine uses a 16-bit address to identify data packets.
4. ***No Dribble Data*** Even in the presence of noise, the FireLine modem will not output extra data or have random bit errors. Modems without packet operation generally do not work well with weak noisy signals.
5. ***Transparent Operation*** Because of the high-reliability and error-free operation the Packet Mode offers the user, most user applications will seamlessly work using the FireLine in its Packet Mode.
6. ***Repeatable and Routable.*** FireLine packets are structured so that they may be repeated using a store-and-forward repeater, and/or routed using specialized hardware.

Streaming Mode Advantages

1. ***Low Latency*** The transmitter will key-up immediately upon the user’s first byte of data entering the modem. Packetized operation waits until a packet has been loaded before keying. (Although high serial-port data rates can minimize this packet latency to a negligible level).
2. ***Data with Errors*** The FireLine will continue to receive data, down into the noise-floor of the radio. If the channel is noisy or the signal is weak, there may be bit-errors in the data, or the FireLine may output additional noise data. User applications must (and often do), take this into account, and

thus can operate with weaker signals and have longer communication range.

Figure 1 (Packet Mode of Operation)

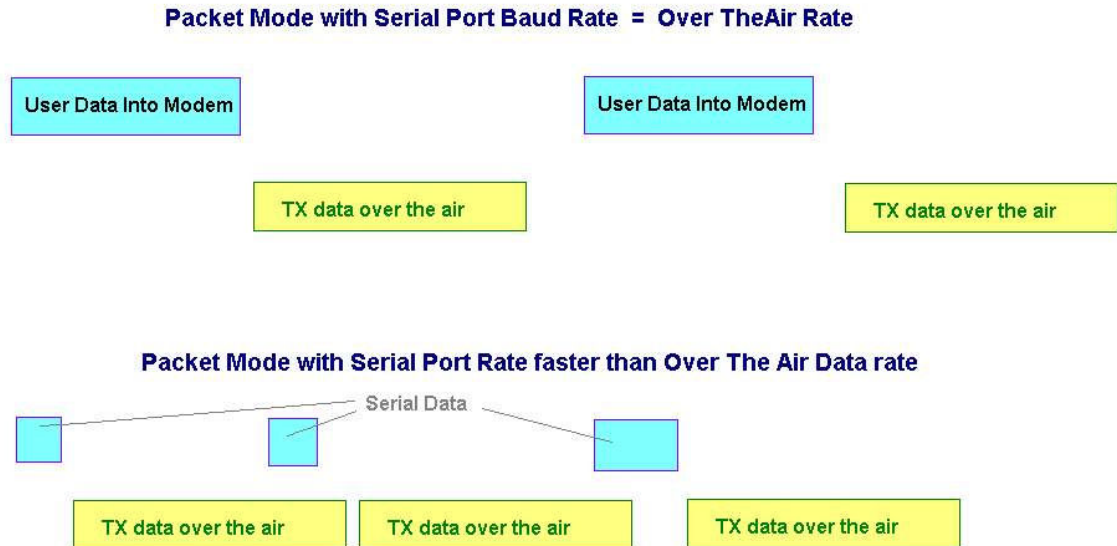

For operation of the modem in the streaming data, non-packetized mode, see the section **Streaming Mode** on page 26. The Packet or Streaming operation is configured using the **ATMT** command, with Packet Mode being the factory default.

5.1. Setup

1. Connect a DC power source to the DC IN connection on the front of the modem.
2. Connect a good quality antenna, cut to the operating frequency, to the BNC connector on the front of the modem. Use a good antenna, and place it at high-above obstructions as possible.
3. Connect a computer terminal, or PC computer running HyperTerminal, to the 9-pin I/O connector. The factory default serial ports settings are 9600 bps, 8 data bits, 1 stop, no parity.
4. Program the modem's operating frequency to your desired operating frequency. This is done with the **ATFX xxx.xxxxx** command. See the section "**Serial Port Commands**" for information describing the various parameters that may be modified in the modem. In most applications, the default settings from the factory will work fine.
5. Using the AT commands, change any of the default operating parameters that must be modified. From the factory, the modems are configured and shipped ready-to-use. Out of the box, they will communicate on the

default radio channel using the factory defaults. In general, the parameters you may want to modify will be:

ATFX	Frequency for this channel. Set to your frequency.
ATMT 0	0 for normal Packetized operation. Default mode.
ATAK	0 for no ARQ, 1 if this unit sends ACKs. Default is no ARQ.
ATRB	Set the number of retries if ARQ is used (x). 0 if no ARQ used. Factory default is no ARQ.
ATBD	Serial port baud rate
ATMY	The ID of this unit. Default is 1234.
ATMK	The network address mask. Default is FFFF.
ATDT	The address of the unit this modem will talk to. Default is 1234.
ATBC	Enable/disable busy channel lock-out. Default is off, 0.

6. Connect your serial data device to the 9-pin connector on the front of the modem.

The radio is now ready to use. Any serial data going into the modem will be transmitted over the air, and any data received over the air will be sent out the serial port.

Remember, that from the factory, all *FireLine* modems are configured to simply work. Plug in power and connect to the serial port at 9600 baud, and the modems will communicate on the default channel. Change the channel frequency to your specific frequency, and they will be ready to work on your channel.

5.2. Programming Channels and Frequencies

The FireLine modem has memory for up to 6 channels. A channel is a pair of frequencies, one for transmit and one for receive. They may be different or they may be the same. You may program any valid frequency into any channel number. To program a channel, perform the following steps.

1. Change to the channel you wish to program, using the **ATHP x** command, where x is the channel number.
2. Program the frequency for this channel x, using the **ATFT**, **ATFR**, or **ATFX** command. Note that the frequency may be entered in MHz as long as you use a decimal point. For Example, enter **ATFX 450.1** to set the channel frequency to 450.100MHz. Alternately, you may enter the frequency in hertz by entering **ATFX 450100000**. You must enter all of the zeros if you enter the frequency in hertz.
3. Review the frequency setting with the **ATFT**, **ATFR**, or **ATFX** command. To see a list of all of the channels, enter **ATF**.
4. To change the radio channel, use the **ATHP x** command while the modem is in the command mode.

If the channel number is changed using the ATHP command, and power is later lost, the channel number will be retained in non-volatile memory as long as was saved using the **ATSV** (Save to non-volatile memory) command.

Due to the nature of the synthesizer used in the FireLine's radio, the frequency programmed into the unit must be an even multiple of its internal reference frequency. For narrow-band radios (12.5kHz channels), the user's frequency must be a multiple of either 6.25kHz or 5.00kHz. For wide-band models, the frequency must be an even multiple of 10kHz or 12.5kHz.

5.3. Data Transmission

To transmit data, simply send one or more bytes of data into the serial port of the modem. When a full packet of data has been collected into the internal buffer of the modem, or when there is a pause in the data, the modem will automatically key its transmitter, and send the data over the air.

Serial Port Baud Rate

While the modem is transmitting, the user may continue to send more data into the *FireLine*. Because the buffers in the FireLine are full-duplex, the serial port data rate and the over-the-air data rates are independent. The serial port baud-rates may be set slow to accommodate legacy equipment, or set at high-speed to minimize latency. The over-the-air data rate is usually 4800 baud for narrow-band channels, and 9600 baud for wide-band, although faster or slower rates may be used.

In Packet Mode, selection of the serial port baud-rate is important. As shown in Figure 1 (Packet Mode of Operation) above, if the serial port baud-rate is the same as the over-the-air baud rate and the packets are short, the channel utilization is only about 50%. But, if the serial port baud rate is set much higher, say 2-8X the over-the air rate, the channel utilization becomes near 100%.

Because the FireLine can handle serial-port data rate far in excess of the over-the-air rate, the efficiency of the FireLine in Packet Mode is approximately the same as other brand modems that cannot operate in a Packet Mode — with the added benefit of ARQ, error-free data, and addressing.

Note that many Windows applications which use the serial port, such as HyperTerminal, put large gaps between the bytes of data they send out the serial port. If an application is not getting the desired throughput, verify that it is not an artifact of the Operating System or the computer.

Flow Control

If large amounts of data will be sent with the *FireLine*, it may be possible to overflow the internal data buffer. To ensure the transmit buffer does not overflow, enable and use hardware flow control. Hardware flow control is enabled with the **ATCH 1** command. Note that the *FireLine* modem will always indicate the status of its internal buffer using the **CTS** signal on the

DB-9 serial connector. When CTS is negated, the internal buffers are more than 80% full. When it is asserted and it is “Clear to Send”, the buffers are less than 80% full.

Packet Size

The over-the-air packet size may be set with the **ATTT xx** command. Once the modem receives one full packet of data into via the serial port, it will automatically key the transmitter and send the data. Factory default is 80 bytes.

Key-On Data

When serial data is entering the *FireLine*'s RS-232 port, the *FireLine* looks for pauses in the data as indication that it is time to send a packet of data over the air. The factory default duration of the pause it looks for is 20mS, but the user may change this to over values using the **ATR3 xxx** command, where xxx is in milliseconds.

Busy-Channel Lock Out

If your system operation require the FireLine modem to monitor-before-transmit, or if you do not want the FireLine to transmit on a channel that is busy, you can enable “Busy-Channel-Lockout”, using the **ATBC 1** command. **ATBC 0** disables BCL, and thus the modem will transmit whenever it has data to send out. The factory-default is BCL disabled. Use caution when enabling it, as a CW interferer, PC with poor shielding, or some other source of RF can stop the modem from transmitting. The threshold where the FireLine senses RF carrier, and determines that the channel is busy is set by the **ATRA** command. This is factory calibrated to an equivalent RF level of approximately -110dBm.

5.4. Data Reception

When the modem receives data over the radio, it checks it for errors, and if it is error-free, it will send it out the serial port. Again, the serial port may be set to any baud rate the user wishes, and the radio receiver and transmitter will continue to operate independently of the baud rate.

When the modem receives a signal, it will assert the CD hardware signal on the RS-232 serial port if it was configured to do so.

In general, the slower the over-the-air data rate, the easier it is for the modem to receive the signal, and thus the more communication range the radio will have. FireLine modems have a unique switched-filter along with digital signal processing, that gives them more range a lower data rates. See Section 8.10 Setting the Over-The-Air Data Rate for more information about choosing the over-the-air data rate.

5.5. Addressing (Packetized Mode only)

Addressing Basics

One of the more powerful aspects of the *FireLine* modem is its addressing scheme. Incorporating addressing in the modem allows multiple radio systems on the same frequency to co-exist, and not interfere with each other. Also, some user application cannot tolerate receiving data that was not intended for it, and by setting the addresses in the modems properly, the system can be configured to allow reception of only data intended for the recipient.

If addressing is not needed or desired, it can be turned off so that all modems receive data from all other modems, and all modems can talk to all other modems.

Each *FireLine* contains a 16 bit address, called its Unit Address, and is represented as a 4 digit hexadecimal number. *FireLine* address may be any number between 0000 and FFFF, which is effectively 65,535 different addresses. Every *FireLine* has a Unit Address programmed into it, as well as the ID of the unit it will send data to. The Unit Address is programmed with the **ATMY xxxx** command, and the Unit Address of the destination modem (the Destination Address) is configured with the **ATDT xxxx** command.

The defaults UNIT ID in all *FireLine* modems is 1234, and 1234 is the default for the destination ID. An Address Mask is used to select which digits of the address will be used to determine if a particular reception was intended for the *FireLine* modem. The default Address Mask is FFFF, which means all digits will be used.

Hexadecimal Numbers

For those not familiar with hexadecimal numbers, a hexadecimal digit represents a 4-bit binary pattern. There are 16 possible values (0,1,2,3,4,5,6,7,8,9,A,B,C,D,E,and F). These 16 values represent 4 bits of information, thus 4 hexadecimal digits can represent 16 bits of information. The hexadecimal numbers represent 4 bit data in the following way:

Hexadecimal Table

Hex #	Binary	Hex #	Binary	Hex #	Binary	Hex #	Binary
0	0000	5	0100	8	1000	C	1100
1	0001	6	0101	9	1001	D	1101
2	0010	7	0110	A	1010	E	1110
3	0011	8	0111	B	1011	F	1111

When communicating over the air, *FireLine* modems transmit their Unit Address and the Destination Address along with the data. Receiving modems check the received Destination Address, and see if it matches their Unit Address. If it does match, the receiving modem outputs the data it received via its serial port. If it does not match, the receiving modem discards the data, and does not send it out the serial port.

Setting A System-Wide Address

If individual addressing is not needed in your system, there are two ways to ensure it is not used. One way is to set all modems in the system with the same Unit Address and destination address. From the factory, these are both set to 1234, and thus, all modems can communicate with all other modems, using the address 1234. The advantage of using this system-wide address, is that if there are other FireLine modems on the channel, but in some other system, they probably will not have the same Unit Address, and thus will not interfere with your system. To reduce the possibility of data cross-talk, the system implementer may wish to use a different system-wide address for the Unit Address instead of 1234. There are over 65,000 addresses available.

An alternate way to disable addressing altogether, is set the Address Mask to 0000 (**ATMK 0000** command). This tells the FireLine to ignore the address, and receive every transmission. The disadvantage to this method is the adjacent-system problem. If there is another FireLine system on the same channel, all modems with the 0000 mask will receive them also.

Most users who do not use individual modem addressing, choose to set a global system address, and have all modems in their system use the same Unit ID and same destination address.

Broadcast Transmissions

The double FF is used to identify a broadcast packet. A transmission with a two digit FF in the first two positions of the destination ID, or in the last two positions of the destination ID, will be interpreted as a broadcast, and any modem with an ID that matches the two non-FF digits will receive the data. For example, sending data with a destination ID of 12FF will be received by any modem with a unit ID 1200 through 12FF. Sending data with a destination ID of FF34 will be received by any modem with a unit ID of 0034 through FF34.

The Address Mask

The reason to use hexadecimal digits to represent the unit address, is that along with the Unit Address programmed into the *FireLine*, there is an "Address Mask" programmed into it. The default mask is FFFF. The address mask is also used to determine if a particular data transmission should be received by the modem. For most applications, where one modem talks to one modem, or where all modems in the system communicate with all other modems in the system, the Address Mask should stay set to FFFF.

Only in systems where some modems should only talk to certain other modems, might you want to change the address mask. Whenever data is received over the air, the Destination Address of the transmission is logically "ANDed" with the Address Mask in the receiving modem. This is the *Effective Destination Address*. The receiving *FireLine* also ANDs its own Unit Address with its Address Mask. The result is the *Effective Unit Address*. The *Effective*

Unit Address is compared to the *Effective Destination Address*, and if the two are identical, the data will be received.

Note: Logically 1 AND 1 = 1, 0 AND 0 = 0, 1 AND 0 = 0, 0 AND 1 = 0

Figure 2 (Address Filtering)

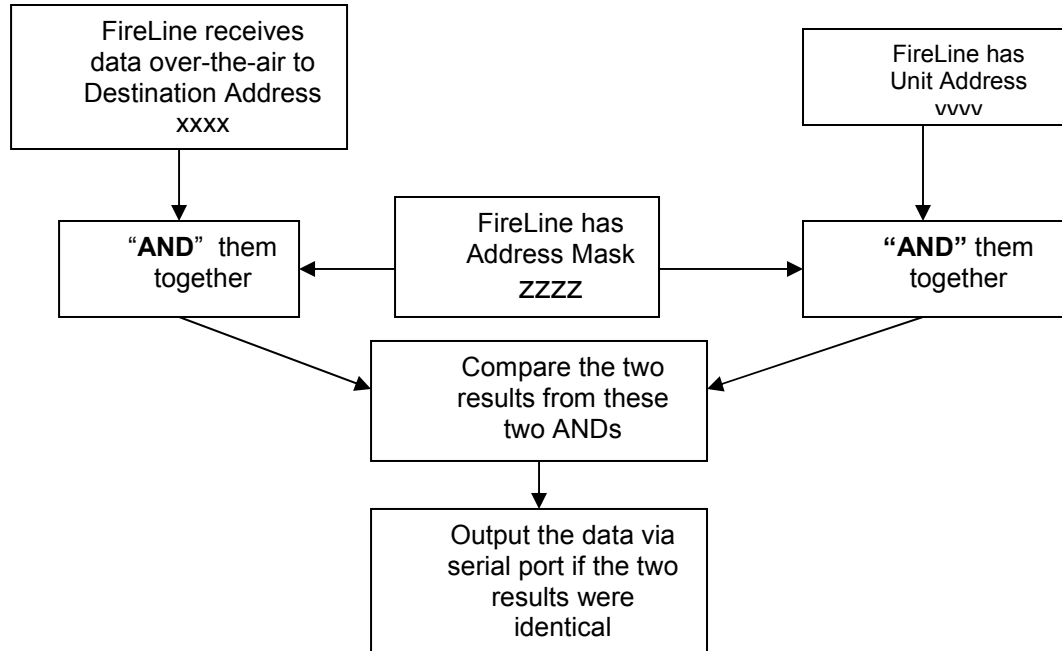

One effect of this is that an address mask of 0000 will cause the *FireLine* modem to received any data from any unit that transmits. The Destination Address will effectively be ignored if the mask is set to 0000.

Addressing Examples:

Example 1 (default configuration)

Sending Destination Address = 1234

Receiving Unit Address = 1234

Receiving Unit's Address Mask = FFFF

Result: Unit will receive the data, because the addresses identically match. When the addresses are identical, the value of the mask is not important.

Notes: This is the default configuration. All units have address 1234, and all modems will talk to all other modems with address 1234.

Example 2 (a configuration that won't work)

Sending to Destination Address = **1236**

Receiving Unit Address = **1234**

Receiving Unit's Address Mask = **FFFF**

Result: No data will be received, because the address do not match, and the address mask of FFFF requires that all digits in the address match. .

Example 3 (able to receive a data from a group, 1230 – 123F)

Sending to Destination Address = **1236**

Receiving *FireLine* Unit Address = **1234**

Receiving *FireLine* Address Mask = **FFF0**

Result: Data will be received. 1236 ANDed with FFF0 is 1230. 1234 ANDed with FFF0 is 1230. The results of the ANDing match, and thus the data will be received.

Example 4 (able to receive from a group, xx34 where xx is any two digits)

Sending Destination Address = **2234**

Receiving *FireLine*'s Unit Address = **1234**

Receiving *FireLine*'s Address Mask = **00FF**

Result: Data will be received. 2234 AND 00FF equals 0034. 1234 AND 00FF equals 0034, therefore they match. The results of the ANDing match, and thus the data will be received.

5.6. Error Correction

The *FireLine* modem has a built-in error correction mode, commonly referred to as *Automatic Repeat request (ARQ)*. It works by checking each reception for errors, and if the data is OK, it sends a short "ACK" packet back over the air telling the sending station the data was OK.

The *FireLine* modem uses a traditional Carrier Sense Multiple-Access (CSMA) algorithm with randomized re-try time slots to determine when to re-transmit packets that must be re-sent. The duration between re-tries increases as the number of attempts increases.

If received data has an error in it or if the receiving modem does not get the data due to interference, the receiving modem does not send the ACK back, and the sending station will automatically re-send the data. There are two aspects to configuring ARQ:

- 1) Enable the ARQ mode in the modem to allow it to transmit ACKs (**ATAK 1** command). This command enables the modem to transmit ACK packets.
- 2) Configure the number of retries the modem should attempt if an ACK packet is not received back when it sends data (**ATRB xx** command). For example, if you set **ATRB** to 5 with the **ATRB 5** command, the modem will wait for an ACK whenever it sends data. If it receives an ACK back from the modem that it sent data to, it will do nothing more. But if it does not receive an ACK, it will resend the same data, trying up to 5 more times.

The factory default condition is not to send or require ACK packets, so if you wish to use this mode, program the *FireLine* to transmit ACKs with the **ATAK 1** command. This will cause the modem to send an ACK anytime it receives data from another modem. Note: If the destination address was a broadcast (FFFF, FFxx, or xxFF), it will not wait for an ACK.

The number of times it retries to send data that does not get through (does not get an ACK) is up to the user, but a number of 5 is usually a good

compromise. If after 5 times, the data does not get through, then there probably is something seriously wrong with the channel or system.

The retried-transmissions are randomly spaced at intervals between approximately 200mS and 400mS, increasing by 50mS for each attempted transmission. Once the modem has sent its data the number of times the user specified in the **ATRB xx** command, the data is discarded, and the modem will continue to operate as normal.

It is very important that if one modem is configured to send ACK packets (**ATAK 1**) that all other modems communicating with it are also set to expect ACK packets using the **ATRB xx** command.

To disable ARQ (the default condition of the modem), disable ARQ with the **ATAK 0** and set retries to zero with the **ATRB 0** command.

5.7. Store-and-Forward Repeating and Routing

The *FireLine* modem has a built-in wireless repeater/router. Each FireLine is capable of not only sending and receiving data from/to its serial port, but also re-transmitting over-the-air data. It is also able to re-transmit data that is addressed to other modems in the system.

Figure 3 Overview of Repeater Operation

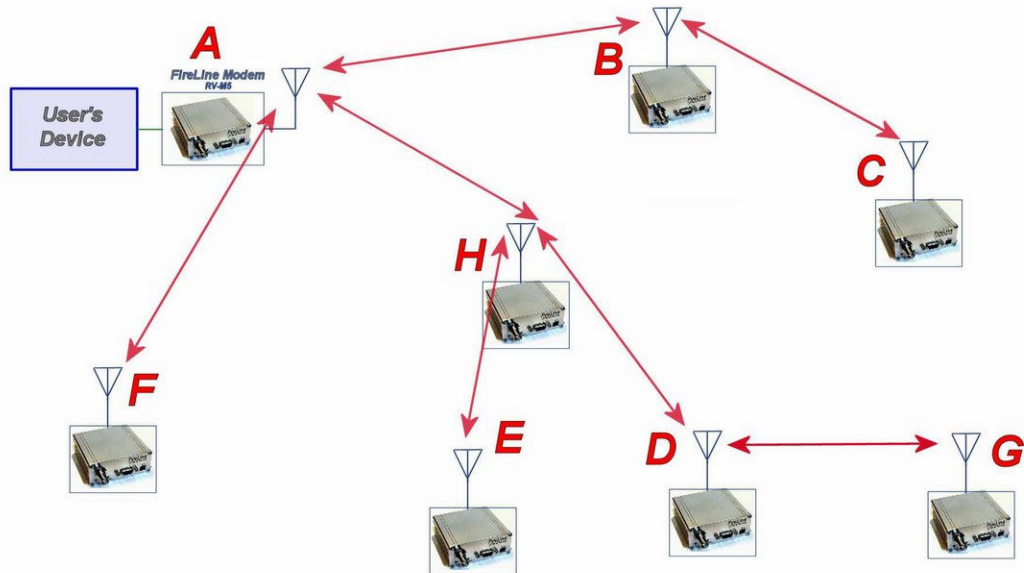

In the example shown in Figure 3 above, *FireLine A* will communicate with all other modems in the system. It can directly communicate with **B**, **H**, and **F**. Because of propagation limits, it cannot communicate reliably to **E**, **D**, **C**, and **G**.

To solve this problem, some of the FireLine modems are configured as repeaters. They still are able to send and receive data, but they also will repeat data out to the modems that are out of range of *FireLine A*.

H is configured to repeat all messages to/from **E**, **D**, and **G**. **B** is configured to repeat all messages to/from **C**, and **D** is configured to repeat all messages to/from **G**.

The following table illustrates one possible way the FireLines could be programmed to accomplish this type of system.

<i>FireLine</i>	<i>Unit ID (ATMY)</i>	<i>Destination (ATDT)</i>	<i>Network Mask (ATMK)</i>	<i>Repeat Source</i>	<i>Repeat Source Mask</i>	<i>Repeat Destination</i>	<i>Repeat Destination Mask</i>
	Addresses programmed into unit			Repeater table programmed into unit			
A	1000	1000	FF00	-	-	-	-
B	1010	1000	FF00	1020	FFFF	1000	FFFF
				1000	FFFF	1000	FFFF
C	1020	1000	FF00	-	-	-	-
D	1030	1000	FF00	1031	FFFF	1000	FFFF
				1000	FFFF	1000	FFFF
E	1032	1000	FF00	-	-	-	-
F	1021	1000	FF00	-	-	-	-
G	1031	1000	FF00	-	-	-	-
H	1022	1000	FF00	1030	FFFF	1000	FFFF
				1000	FFF0	1000	FFFF

Store-and-forward repeating is enabled with the ATXR command. **ATXR 1** enables repeating. **ATXR 0** disables it.

The *Repeat Source*, *Repeat Source Mask*, and the *Repeat Destination* are programmed into a Repeater Table in the FireLine. The ATX command is used to program the Repeater Table. The Repeater Table may have up to 4 entries.

For example, FireLine **B** in the above example will have two entries in its Repeater Table. The command to set the two entries is:

ATX1 1020 FFFF 1000 FFFF
ARX2 1000 FFFF 1000 FFFF

The first command above sets the Repeat Source to 1020 and the Repeat Destination to 1000, both with a Mask of FFFF. The FFFF mask means all digits of the source and destination are used to determine if the transmission should be repeated. All packets from units with MYID 1020 (**C**) sent to 1000 will be repeated by this unit. It will not repeat messages from **D**, **E**, **F**, **G**, or **H** because their Unit IDs are not in the *Repeat Source* repeater table.

The second command above sets the Repeat Source to 1000 and the Repeat Destination to 1000, both with a Mask of FFFF. The FFFF mask means all digits of the source and destination are used to determine if the transmission should be repeated. All packets from units with MYID 1000 (**A**) sent 1000 will be repeated by this unit. In other words, all transmissions from **A** will be repeated by **B**.

To view the Repeater Table, use the **ATX** command, with no parameter. To view a single entry in the table, use the **ATXn**, where n=1, 2, 3, or 4.

To delete an entry in the table so it has no effect on the operation, set the fields to 0. For example, to disable make entry 1, use the **ATX1 0 0 0 0** command.

Using the FireLine Modem – Streaming Mode

This section describes the operation of the Streaming Mode of operation. This mode is selected with the command **ATMT 2**.

5.8. Streaming Mode Operation

In Streaming Mode, radio transmissions will begin whenever data enters the mode, and the transmission will continue as long as there is data to send. The transmitter will automatically key when data enters the modem, and there is no need to assert any control lines. It will automatically de-key when there is no more data to send.

Figure 3 illustrates the difference between the Packet Mode and the Streaming Mode of operation.

Figure 4 (Streaming Mode of Operation)

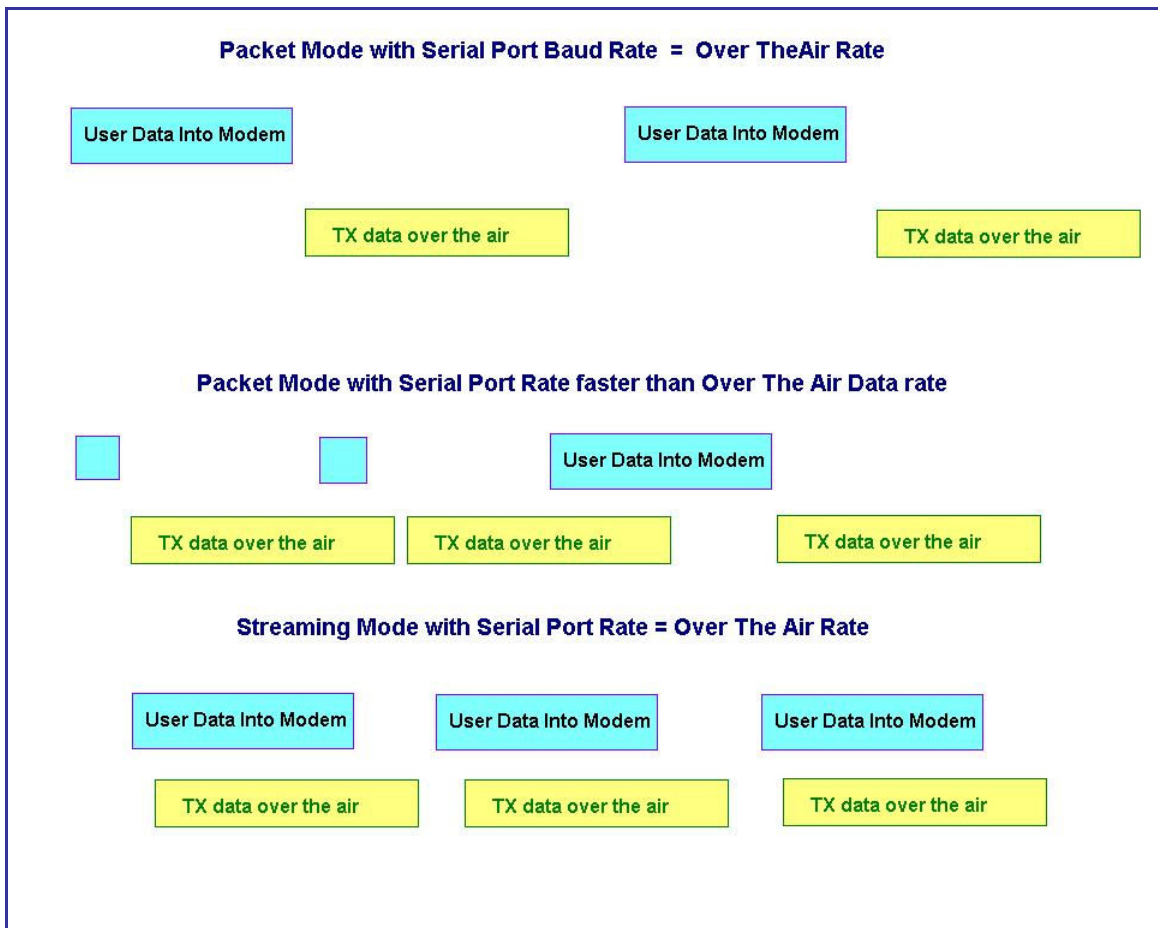

For operation of the modem in the Packetized Mode, see the section on page 15 entitled

Using the FireLine Modem – Packet Mode.

5.9. Baud Rate Selection

In Streaming Mode, the user data may still enter the modem at any baud rate, as set with the **ATBD x** command. The *FireLine* modem will buffer the data and send it out over the air in the same order as it enters the modem. When the buffer is empty and there is no more data coming into the modem, it will automatically de-key the radio and go back into the receive mode. The *FireLine* modem will send a hidden end-of-message signal to the receiving modem, thus avoiding any extra data bytes “*dribble bytes*” from coming out of the user serial port. When the modem is operating with very weak signals, the end-of-message signal may be obscured, and missed by the receiving *FireLine*. In this case, additional noise bytes may come out of the user serial port.

While receiving, the modem will also output the receive data out the serial port at the rate set by the **ATBD** command. If the serial port baud-rate is slower than the over-the-air rate, an internal buffer in the *FireLine* modem will hold the data as it is sent out the serial port.

5.10. Bit Errors

Unlike Packet Mode operation, there is no error-detection nor error-correction in the Streaming Mode, so user data may contain bit errors. The user’s application must be able to handle these errors or additional bytes of noise data.

If the application that is using the *FireLine* cannot tolerate have erroneous data when the channel is noisy, the modem should be operated in the Packet Mode instead of Streaming mode (In Packet Mode, data is always first checked for bit-errors, and never outputted if it detects any errors).

The end of a transmission is detected by the receiving modem by the presence of a special end-of-message signal. Transmitting *FireLines* automatically put the end-of-message signal out after the user’s data has been transmitted. If the receiving modem does not receive this signal (due to noise or interference), the receiving modem may continue to output some more data, until it detects that the RF carrier is gone, or the received signal is actually noise. This may take a byte or two of time, and during this time period, the receiving modem may output random noise bytes.

5.11. Carrier Detect

To reduce, and virtually eliminate bit errors and additional noise bytes, the user may configure the *FireLine* to require and RF carrier Detect before receiving any data. Because the RF carrier Detect Threshold is set above the noise-floor of the receiver, bit-errors will be rare if RF carrier is required to receive. By default, the *FireLine* does not require RF carrier detect to receive. To enable it, use the **ATRF 1** command. To disable the need for RF carrier detect, us the **ATRF 0** command (Factory default).

When **ATRF** is **0**, the modem will be more sensitive, and be able to receive weak signals, but there is more likely to be bit errors when the signals are weak.

5.12. Serial Data Flow Control

If large amounts of data will be sent with the *FireLine*, and the serial port is operated at a faster data rate than the over-the-air rate, it may be possible to overflow the internal data buffer. To ensure the transmit buffer does not overflow, enable and use hardware flow control. Hardware flow control is enabled with the **ATCH 1** command. Note that the *FireLine* modem will always indicate the status of its internal buffer using the CTS signal on the DB-9 serial connector. When CTS is negated, the internal buffers are more than 80% full. When it is asserted and it is “Clear to Send”, the buffers are less than 80% full.

6. Installation

1. Secure the *FireLine* modem using the four mounting holes on the side flanges of the unit.
2. Connect a DC power source to the DC IN connection on the front of the modem. Use the supplied cable, and connect the RED wire to +, and the black wire to – (ground). The black wire and the case of the *FireLine* should be connected to earth ground.
3. Connect a good quality antenna, tuned to the operating frequency, to the RF connector on the front of the modem. Use a good antenna, and place it as high-above obstructions as possible.
4. A separation distance of at least 20 centimeters must be maintained between the transmitter's radiating structures and the body of the user or nearby persons.
5. Connect the computer, terminal, controller, or other hardware device that will be using the *FireLine* modem to its DB-9 serial I/O connector using a shielded cable. Secure it to the *FireLine* with the two mounting screws on the sides of the DB-9 connector.
6. If the antenna is mounted outdoors, use a lightning arrestor in-line with the antenna, and properly ground the antenna and the *FireLine* chassis to an earth ground.

7. FCC Licensing Information

FireLine radio modems operate on radio frequencies that are regulated by the Federal Communications Commission (FCC). In order to transmit on these frequencies, you are required to have a license issued by the FCC.

Almost everyone engaged in public safety activities - as well as private organizations, are required, to obtain a radio station license from the Federal Communications Commission if they wish to use a radio transmitter.

The FCC will help you through the licensing process.

You can find the basic information you need to begin the process at the FCC website. If you are engaged in public safety activities, you can go directly to:

<http://wireless.fcc.gov/publicsafety>

If you are a business, commercial, or institutional organization, you can go directly to:

<http://wireless.fcc.gov/services/ind&bus>

In either case, you will be shown the regulations and the information you will need to gather before you get started - your desired operating frequencies,

wideband/narrowband, antenna type and size, power/wattage, etc. You'll also get information on how to obtain the necessary application forms - either in hard-copy or electronic format - and how to proceed.

The FCC website also offers a list of Frequency Coordinators. These are private organizations officially certified by the FCC to help you through the process, and who in most cases will handle the actual filing of your application. With few exceptions, you must apply for an FCC license through a Frequency Coordinator. They are located throughout the country, making it easy for you to find one that is familiar with radio operations in your area.

There are companies who specialize in assisting with licensing radio modems. You may consider contacting one of the following:

Atlas License Company and Data Services

1-800-252-0529

<http://www.alcads.com>

Airwaves Licensing

1-717-334-0910

<http://www.airwaveslicensing.com>

8. User Serial Port Commands

8.1. Overview

The asynchronous serial portion the RF modem is used to send and receive data over the air, as well as to configure the RF modem. In normal operation, the user sends data into the TxD pin of the user port, and this data is transmitted over the air. Received data from another RF modem is output to the user via the RxD pin of the user port. This is the default operating condition of the RF modem. No special characters, hardware control lines, or timing is required to operate the *FireLine* modem.

There is also a “Command Mode” used to program and configure the *FireLine*. In the Command Mode, the *FireLine* modem accepts commands via the serial port TxD pin. The commands can be used to change certain internal parameters of the *FireLine* modem as well as to read-out the current configuration and diagnostic statistics.

8.2. Command Mode

The *FireLine* modem may be put into a “Command Mode”, by entering a sequence of three plus characters (+++). To keep the *FireLine* modem from unintentionally entering the Command Mode because of the +++ pattern occurring in a stream of data entering the modem, there must be a pause in the data stream before the +++ as well as a pause after the +++ is sent. If either pause is missing, the modem will not enter the command mode.

Using serial communications software such as *HypterTerminal*, send the 3-character command sequence “+++” while observing times of silence before [BT (Silence Before Sequence) Command] and after [AT (Silence After Sequence) Command] the command characters. The default BT and AT times are 500mS.

The default sequence for entering into AT Command Mode:

1. No characters sent for ½ a second.
2. Input three (3) plus characters (“+++”) within ½ of a second.
3. No characters sent for ½ a second.

When the *FireLine* modem first enters the Command Mode, it sends the phrase “*FireLine*” out it serial port, and then an “OK” sequence. The “OK” sequence is a sequence of 4 characters:

An “O”, “K”, <CR>, and <LF> characters (<CR> = ASCII 0D, <LF> = ASCII 0A)

8.3. Setting a Parameter

To set a parameter in the *FireLine* modem, enter the Command Mode as described above. Then enter the proper AT command, a space, the parameter, and then a carriage return. For Example, to set the address of the *FireLine* modem to 1234, enter the following command:

ATDT 1234 <CR>.

Once a Parameter is changed, the modem will begin using the new parameter as soon as it exits the Command Mode and returns to its normal operation mode. If the new parameter was saved to non-volatile memory using the **ATSV** command, then the new parameter will be used as well the next time the FireLine modem is powered on.

If a parameter is changed, but the **ATSV** command is not issued, the new parameter is used to operate the modem, but when power is turned off and back on, upon powering up, the FireLine will revert back to the previously saved parameter value. If parametric changes are to be permanent, always issue the **ATSV** command after all parameter changes have been made.

8.4. Reading a Parameter

To read the value of a particular setting, issue the command, with no parameter. The modem will return the value followed by an "OK". The modem's OK response is:

The value in ASCII decimal format.

A <CR> <LF> (<CD> = ASCII 0D, <LF> = ASCII 0A).

An "O", "K", <CR>, and <LF> sequence.

For example, if the user enters the command to read the *FireLine's* modem address and its address was 1234, the user would issue the following command:

ATDT<cr>

and the modem will respond with:

1234 <CR> <LF> OK <CR> <LF>

To get on-line help with a command, enter the command and put a question mark in for the parameter. For example, to see what the ATDT command is for, type **ATDT ?**. The modem will respond by listing a brief description of the command. To see a list of all commands, type **HELP**.

8.5. CONFIG Button

If certain parameters within the modem are modified in a manor that causes the modem to cease functioning or if the user cannot enter the command mode via the "+++" method described above, there is a small push button internal to the *FireLine* modem to assist in this case. This CONFIG button may be pressed at any time, and forces the modem into a known operational state. The CONFIG button is located inside the modem. Remove the rear cover, exposing the two circuit boards. The button is in the center of the lower circuit board as shown below.

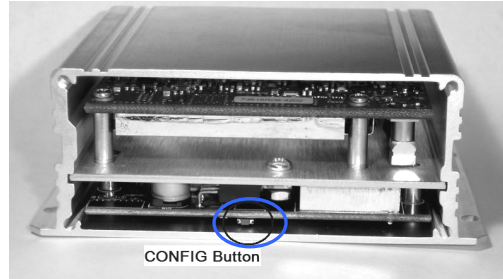

The default settings that the modem will revert to when the CONFIG button is pressed are:

1. *Serial port 9600 baud, 8 data bits 1 stop, no parity*
2. *ATCT setting set to 60000 (60 second time-out)*
3. *Serial port on the front of the unit in RS232 mode, 9600bps, N/8/1.*

If the unit was configured for RS-485, RS-422, or Ethernet, you must disconnect other devices and use an RS-232 device to configure the FireLine.

Even though the serial baud rate reverts to 9600 baud when the CONFIG button is pressed and the IO port is RS232, it will revert back to the settings programmed into the *FireLine* modem once the Command Mode is exited.

8.6. Exiting the Command Mode

There are three ways to exit the command mode. They are:

1. **ATSV** Issuing the **ATSV** command saves the current configuration to non-volatile memory, and then returns to the normal operation mode.
2. **ATCN** Issuing the **ATCN** command does not save the current configuration, but it does cause the modem to continue to operate. If changes to the configuration were done in the Command mode, these changes will be used in operation, but they are not be saved to non-volatile memory. The next time the modem is powered down and back up, the modem will operate with the previously saved settings.
3. **Time Out.** After a pre-set amount of time (60 seconds is the factory default time), the modem will automatically exit the Command Mode, and continue normal operation. Changes will not automatically be saved. This time-out duration may be set with the **ATCT** command.

8.7. Restoring Factory Defaults

The **AT&F** command may be used to restore the modem back to the factory-default condition. Use this command with caution, as it will erase all previously configured parameters. It will cause the modem to revert back to the factory-defaults, as shown in the command table, "Factory Default" column. The only parameters that it does not restore to default are the radio type and radio calibration values R0-R9, and RA. This is so that the user may restore defaults, and not have to re-calibrate the radio.

To erase ALL parameters, including the radio type and radio calibration, issue the **AT&F 123** command. There should not be any reason do this command, because it will require the radio to be re-calibrated per the factory alignment procedure.

8.8. Command Mode Commands

AT Command	Command Description	Parameters	Factory Default
AK	Enable/Disable ARQ – When ARQ is enabled, this modem will automatically send an ACK packet back to a modem that sends it data. 0=off, 1=on.	Range: 0 – 1	0 (no ACKs sent)
AS	Auto Status Report Interval – Sets the time between auto status reports. Time is in minutes. 0 means disabled.	Range: 0 –56000 (minutes)	0 (Off)
AT	Silence AFTER Sequence - Sets period of silence after the command sequence characters in mS.	Range:0 – 1000 (mS)	500
BD	Baud Rate – Sets serial com port baud rate (bps). Over-the-air (throughput) baud rate is set with ATR2 command. If a PC's serial baud rate is set higher than the fixed over-the-air baud rate of the module, hardware handshaking may be required.	Range: 0 – 6 0 = 1200 bps 1 = 2400 2 = 4800 3 = 9600 4 = 19200 5 = 38400 6 = 57600	3
BC	Busy Channel Lock Out – Enable/disable the BCL. If enabled, the modem will not transmit on a radio channel that is busy (has RF on if). 0-OFF, 1=ON.	Range: 0-1	0
BT	Silence BEFORE Sequence – Sets period of silence before the command sequence character in mS.	Range: 0-1000 mS	500
CH	Configure Hardware Flow Control – Enable (1) or disable (0) flow control. When enabled, the modem will monitor the RTS line, and if it is negated, stop sending data out the serial port. If disabled, the modem will ignore the state of RTS, and always send out charators.	1 = Enable 0 = Disable	0
CN or O	Exit AT Command Mode – Exits module from AT Command Mode and returns it to Idle Mode. Parameters are not saved in EEPROM.	none	none
CT	Time Out from AT Command Mode – If no valid commands have been received within this time period (in milliseconds), modem returns to normal operation mode from Command mode. If the CONFIG button inside the <i>FireLine</i> is pressed, this parameter will be automatically set to 60000.	Range: 100-60000mS	60000
DT	Destination Address to call – Sets address of the modem to send data to. Note, this parameter is entered in HEX format. Each digit may be a 0,1,2,3,4,5,6,7,8,9,A,B,C,D,E,or an F.	Range: 0-FFFF	1234
E	Echo – Character echo set on (E1) or off (E0). This applies to the Command Mode only.	Range: 0 , 1	0 (no echo)
F	Display frequencies – Display all of the frequencies programmed into all of the channel memories.		N/A
FT	Transmit Frequency – Program the transmit frequency for this channel. Enter in Hz or in MHz. The frequency will automatically be saved in non-volatile memory (flash) for this current channel number.	Range: See product data sheet. For MURS products, frequency cannot be changed.	See product data sheet.

FR	Receive Frequency – Program the receive frequency for this channel. Enter in Hz or MHz. The frequency will automatically be saved in non-volatile memory (flash) for this current channel number.	Range: See product data sheet. For MURS products, frequency cannot be changed.	See product data sheet.
FX	TX and RX Frequency – Program the receive and transmit frequency for this channel. Enter in Hz or MHz. Same as issuing an ATFR and an ATFT command. The frequency will automatically be saved in non-volatile memory (flash) for this current channel number.	Range: See product data sheet.	N/A
HP	Channel Number – Select separate channels to minimize interference between multiple sets of modules operating in the same vicinity.	Range: 1 - 6	1
IO	Configure the I/O The proper hardware option must be installed in the modem. All <i>FireLine</i> modems support RS-232 mode.	Range: 0 - 5 0=RS232 1=Ethernet 2=RS485 dup 3=RS485 simplex 4=RS422 5=GPS	0
L	Enable/Disable the LEDs – 1 = LEDs always off. This reduces some power consumption. 0 = LED operate normally.	0 or 1	0
MA	Monitor Address – – Configures the address that status transmissions are sent to. Only used if Auto Status is enabled. Each digit may be a 0,1,2,3,4,5,6,7,8,9,A,B,C,D,E,or F. Note: FF is interpreted as a group. See addressing section.	Range: 0000 - FFFF	FFFF
MK	Address Mask – Configures local and global address space. Each digit may be a 0,1,2,3,4,5,6,7,8,9,A,B,C,D,E,or F. In most applications, this is kept at FFFF.	Range: 0000 - FFFF	FFFF
MT	Protocol Select – The over-the-air communication protocol. 0=Packetized mode, 2=Streaming data.	Range: 0-2	0
MY	Unit Address – Configures the individual; address for this unit. Each digit may be a 0,1,2,3,4,5,6,7,8,9,A,B,C,D,E,or F. Note: FF is interpreted as a group. See addressing section.	Range: 0000 - FFFF	1234
NB	Parity – Selects parity format. Settings 0-4 transfer 8-bits over antenna port and generate the parity bit on the RF receiving side.	Range: 0 – 5 0 = none 1 = Odd 2 = Even 3 = Mark (1) 4 = Space (0)	0
NS	Stop Bits – Selects the number of stop bits.	Range: 1-2	1
PE	Packet Error Display – Shows statistics to compute packet-error rate. Displays Packets Per Minute (PPM) and a running total.	None (display PER) 1 = reset counters 2 = Stop PER display	None
R0	Symbol Peak Deviation – Set the peak FM deviation of the transmit symbols. Note: This can be a negative number to invert the modulation.	Range: -1000 – 1000	120**
R1	Select CD pin output signal – CD may be RF carrier detect, or modem data detect.	Range : 0 - 2 2 = Always assert CD 1 = Data CD 0 = RF CD	1
R2	Over-The-Air bit rate - This is the data rate the radio uses to send data over the air. All RF modems in the network must use the same over-the-air baud rate. Refer to section 8.10 for information on how to set the OTA baud rate.	Range: 0 = 800 6 = 19200 4L 1 = 1200 7 = 5142 2L 2 = 2400 8 = 9600 4L 3 = 4800 9 = 2000 2L 4 = 8000 4L 10 = 16000 4L 5 = 9600 2L	3
R3	Serial Port time out – Number of mS of no activity before transmitting.	Range: 1 - 5000	20 (mS)
R5	Preamble length – The number of bytes to send over-the-air in the pre-amble.	Range: 3 - 255	4** (Varies based on

			data rate and radio type. 7 typical)
R8	Frequency Offset. Used to set the radio on the center of the radio channel.	Range: -500 to +500	0**
R9	Modulation Balance.	Range: 0-100	20**
RA	Select RF CD output threshold – This value is the RSSI threshold where the carrier detect is asserted. Note: To force CD always on, set this to 0, and R1 to RF Carrier Detect.	Range : 0-999	300**
RB	Number of retries. If this modem does not get an ACK back when it sends data, this is the number of times it will re-transmit the packet and wait for an ACK. 0=disabled feature.	Range: 0-99	0 (ACKs are not used)
RF	RF Carrier Required – When enabled, there must be RF energy on the channel for the modem to output data. Streaming data mode only. 1=RF required. 0=ignore rf energy when receiving.	Range: 0, 1	0 (no RF required)
RG	Transmit Time-Out-Timer – Sets the transmitter time-out-timer in seconds. This is a fail-safe timer for improper configuration or operation of the modem. In normal operation, the TOT setting is not changed.	Range: 0-999 (seconds)	60
RP	LPM Operation Enable – When set to 1, the DTR input line controls the FireLine's low-power operation. When set to 0, the FireLine will not go into LPM, regardless of the state of the DTR pin.	Range: 0, 1	0
RQ	Receiver Signal Level – Reads the Receiver Signal Strength this instant, and returns the level in dBm.	Range: -40 to -140 (dBm) varies by model	-
RS	RSSI (Receive Signal Strength Indicator) – Returns the signal level of last received packet. The reading is in dBm.	No parameters. Returns a number : -40 to -140 (dBm) varies by model.	none
RT	Radio Type – Select the type of radio module installed within the modem. <i>If this parameter is changed, you must fully recalibrate the modem.</i> The type of radio module installed is listed on the serial number. Various	Range: 1-9 2 = RV-M5-UC _(DM3473) 3 = RV-M6-UC _(DM3475) 5 = RV-M5-UC-W 7 = RV-M5-Vx	2**
RV	Enable Remote Access – When enabled (set to a 0), the modem will respond to over-the-air RPR requests and over-the-air commands. Default is ON (0).	0= Remote Access on 1=Remote Access off	0
SL	Serial Number – Reads and returns a unique serial number for thjs unit.	Read Only 1 - 999999999	unique
SH	Show – Display the configuration of the modem. This will return a page of ASCII characters, showing the main configuration parameters.	none	None
SV	Save – Save all the parameters to EEPROM. This command must be used if changed parameters are to be stored in non-volatile memory, and used next time the modem is powered up. Modem exits configuration mode after this command is executed. It saves all parameters except the frequency (The frequency is automatically saved when an ATFT, ATFR, or ATFX command is executed)	none	None
TD	Transmit Random Data – When issued, the modem will begin sending random data. Entering a <CR> will terminate the transmission.	0 = Go back to normal 1 = Random 2 = Hop up/dn one channel 3 = Force PLL to fast 4 = TX all 0s 5 = TX all 1s 6 = Test Points ON	

		7 = Transmit CW 8 = Transmit 1010101...	
TT	Max Packet Size – Set the maximum number of bytes in an over-the-air packet.	1 - 512	240
VB	Read DC input Voltage – Returns the DC input voltage reading, in mV (12500 = 12.5VDC input).	None	none
VR	Firmware Version – Returns firmware version currently loaded on the module.	Read Only, 3 characters	none
Xn	Show or Configure the Repeat Table – Set the addresses that this unit will store-and-forward data to/from. n = 1, 2, 3, or 4 designating the entry in the table to show or edit..	<i>Four parameters</i> aaaa bbbb cccc dddd where aaaa=Source Address bbbb = S.A. Mask cccc = Destination Address dddd = D.A. Mask	
XR	Enable/Disable Store and Forward Repeating – 0=disabled, 1 – enabled.	0 or 1	0 (Off)
&F	Restore Factory – Restore the factory default values. This command will not erase the calibration values. After this command executes, the modem will still be in the CONFIG mode.		none

** indicates values that are calibrated in the factory and are unit-specific. If the "Radio Type" is changed, these will need to be re-calibrated.

8.9. Default Frequencies

Channel 1 464.500 MHz

8.10. Setting the Over-The-Air Data Rate

The SkyLine has programmable over-the-air baud rates. The over-the-air rate is stored in register R2, and is programmed with the **ATR2 x** command, where **x** is a number corresponding to the rate. There are 8 possible baud rates, but not all rates may be used with all radio modem models. Consult the following table.

Over-the-air rate	Radio Bandwidth	Number of Modulation Levels	FireLine Modem Models that support the rates
800bps (R2=0)	12.5kHz or 25kHz	2	RV-M5-UC-N, RV-M5-UC-W
1200bps (R2=1)	12.5kHz or 25kHz	2	RV-M5-UC-N, RV-M5-UC-W
2400bps (R2=2)	12.5kHz or 25kHz	2	RV-M5-UC-N, RV-M5-UC-W
4800bps (R2=3) Default setting	12.5kHz or 25kHz	2	RV-M5-UC-N, RV-M5-UC-W
8000bps (R2=4)	12.5kHz or 25kHz	4	RV-M5-UC-N, RV-M5-UC-W
9600bps (R2=5)	25kHz	2	RV-M5-UC-W
19200bps (R2=6)	25kHz	4	RV-M5-UC-W (will not work with Radio Type 5)
16000bps (R2=10)	25kHz	4	RV-M5-UC-W (will not work with Radio Type 5)
5142bps (R2=7)	12.5kHz or 25kHz	2	RV-M5-UC-N, RV-M5-UC-W, RV-M5-UC-S
9600bps (R2=8)	12.5kHz or 25kHz	4	RV-M5-UC-N, RV-M5-UC-W

Changing the over-the-air data rate will change the sensitivity of the receiver. Higher-data rates require a stronger signal at the receiver to be properly received. The default over-the-air data rate for *FireLine* radio modems is 4800 baud for narrow-band versions, and 9600 baud for wide-band versions.

The maximum over-the-air baud-rate for a narrow-band radio (12.5kHz channel-spacing) is 9600bps. Due to IF filter limitations, the *FireLine* does not work as well at 9600 baud as some other rates. Its performance is optimized for 4800 baud 2-level modulation and 8000 baud 4-level modulation.

The maximum over-the-air baud-rate for a wide-band model (25kHz channel spacing) is 19200bps. Due to IF filter limitations, it does not work as well at 19200 baud as lower data rates. Its performance is optimized for 9600 baud 2-level modulation or 16000 baud 4-level.

RV-M5-UC (narrow-band version)

Factory default, set R2 to 3 (4800 baud).

For **high-speed operation**, set R2 to 4 (8000 baud).

For **best range** (longest distance), set R2 to 1 (1200 baud)

Other data rates of 0(800bps), 2(2400bps), 3(4800bps), and 7(9600bps) will work, but have a less optimal bit-error-rate vs. receive sensitivity.

RV-M5-UC-W (wide-band version)

For **high-speed operation**, set R2 to 5 (9600 baud).

For **best range** (longest distance), set R2 to 1 (1200 baud)

Other data rates of 0(800bps), 2(2400bps), 3(4800bps), 7(9600bps), and 6(19,200bps) will work, but have a less optimal bit-error-rate vs. receive sensitivity.

8.11. Debug Related Commands

Bench Testing

(Must be in command mode to test. Enter +++ at the keyboard to put unit into config/test mode.)

ATTD x	Various transmit test routines. 0 = Go back to normal mode. Stops the test. 1 = Random data transmit. 2 = Hop up/down one channel 3 = Force PLL to fast lock mode 4 = Transmit all 0s 5 = Transmit all 1s 6 = Enable the test points on the PCB. 7 = Transmit CW on center of channel 8 = Transmit preamble (101010 pattern)
SHOW	Display an overview of the configuration.
ATST	Display statistics of how the modem is working.
AT\$5	Display RSSI. It will scroll the reading until another character comes in the serial port.

Packet Counter

The packet counter mode will output packet count statistics once per minute. It will output the number of packets received in the last minute as well as the running total. T

ATPE Begin counting and displaying the packet counters every minute

ATPE 1 Reset the packet counters back to zero

ATPE 2 Stop counting and displaying packet counters

Upon power up, the packet counter feature is always disabled.

9. FireLine Diagnostic Provisions

9.1. Overview of Diagnostics

Internal to the *FireLine* radio modem, is a powerful 32-bit microprocessor. Along with handling all aspects of radio modulation and demodulation, the microprocessor also maintains an extensive array of diagnostic information.

This section details the diagnostic information available, and describes how to use the information to optimize or troubleshoot a *FireLine* radio network.

9.2. Reading the Diagnostic Information

FireLine diagnostic information is read using AT commands, while the unit is in the Command Mode. Refer to the section “User Serial Port Commands” to learn how to put the *FireLine* modem into the Command Mode.

To see a general overview of how the modem has been operating, use the **ATST** command (status request command), without any parameter. The radio modem will respond with a list of certain operation statistics that it maintains. All statistics start counting at 0. The ATST 1 command can be used to reset all statistics back to 0, except the run-time timers.

Other operation and configuration statistics are available using the ATST command, with a parameter to specify the desired statistic. The following table describes the various statistics available.

9.3. Status and Statistics Command

AT Command	Command Description	Response
ST	General Communication Statistics – This command will cause the <i>FireLine</i> to output a table of various operational statistics.	Statistics overview screen
ST1	Reset Statistic Counters – All statistic counters will be reset to 0.	OK
ST2	Low-level internal statistics – Returns various low-level statistics. These are subject to change in various firmware revisions.	Low-level statistics screen
ST3	Compile date and time – Returns the date and the time that the firmware was compiled.	Date and time
ST4	Run Time – Returns the amount of time that the modem has been powered up and running.	Run time display screen
ST10	Statistic Read – Returns numeric values, comma separated, of all statistics as described in the ST command.	Run time display screen

9.4. ATST Command

The ATST command, will return the following information:

```
STATISTICS
Good RX Packets      : nnn (packets received over the air with no bit-errors and correct address)
With Bad CRCs       : nnn (over-the-air packets with bit errors that were discarded)
With Bad Noise      : nnn (receptions that were aborted due to noise, CW jamming, lost signal...)
Bytes received      : nnn (number of bytes this modem received, and sent out its serial port)
Bytes transmitted: nnn (number of bytes this modem received via the serial port, and
                        transmitted over the air)

Packets send       : nnn (number of packets this modem has transmitted over the air.
                        Retransmissions in the ARQ mode are not counted)

ACKs received      : nnn (Number of ACK packets this modem received, when ARQ was
                        enabled)

ACKs transmitted   : nnn (Number of ACK packets sent over-the-air in the ARQ mode)
Pkts last minute   : nnn (Number of packets received during the last minute)
UART errors        : nnn (serial port framing and overrun errors. Usually these are caused by
                        incorrect serial port settings)

OK
```

If there is a hardware problem, there may be one or more hardware error messages listing the error types (CPU Exceptions, OS Rebooted, or Fatal OS failures). Consult the factory if any of these messages ever appear.)

9.5. ATST2 Command

The ATST2 command, will return additional lower-level statistics:

```
RF FIFO overruns   : nnn (number of times the modem was too busy to receive data over-the-air)
Wrong address      : nnn (packets with addresses intended for some other unit. Also will count
                        apparent false packets due to random noise)

Duplicate packets: nnn (number of packets discarded because they already were received, and
                        subsequently re-received due to ARQ mode or a repeater)

Missing ACKs       : nnn (number of transmissions in ARQ mode, where this sending FireLine did
                        not receive an ACK back as it expected to)

TX FIFO overflows: nnn (number of bytes of data that came into the FireLine over-the-air, and
                        there because there was no buffer space for the data, were discarded.
                        If greater than 0, the serial-port baud-rate should be increased. )

RX FIFO overflows: nnn (number of bytes of data came into the FireLine's serial port, and there
                        was no room in the FireLine to buffer the data before transmission, so
                        these bytes were discarded. If greater than 0, flow-control should be
                        enabled, hardware flow-control implemented, or the serial-port baud
                        rate reduced.)

OS loop time       : nnn (number of times OS executes, per baud. Typical 10-200. 0 or >5000
                        means there is a serious OS problem).

OS Speed           : nnn (speed of the main Operating System, in Hz. Typical 8000-30000. )
VCO Bias           : nnn (the DAC value that biases the VCO in the radio. 0-1024 = 0-3.3V)
Config             : hhhh (hexadecimal representation of an internal configuration word.)

OK
```

9.6. ATST3 Command

The ATST3 command, will return the time and date the firmware in the *FireLine* was compiled.

9.7. ATST4 Command

The ATST4 command will return internal timers that tell how long the modem has been powered up and running. All of these timers restart a 0 upon power up.

```
Run time:
Years: nnn (number of years running)
Days : nnn (number of days running, resets to 0 after one year)
Hours: nnn (number of hours running, resets to 0 after 23 hours, 59 minutes, 59 seconds)
Min:   nnn (number of minutes running, resets to 0 after 59 minutes, 59 seconds)
Sec:   nnn (number of seconds running, resets to 0 after 59 seconds)
Uptime: nnn (number of seconds running. Does not reset.)
OK
```

9.8. AutoStatus

The auto-status feature of the FireLine enables it to automatically transmit a packet of status information. By default, this feature is disabled.

To enable the Auto Status feature, use the **ATAS xxx** command, where **xxx** is the status interval in minutes. The interval may be between 1minute an 65000 minutes (45 days).

The general format of the message that the modem will send is:

```
[an ASCII STX character, 02]
BEGIN STATUS
ATMY=1234
ATVR=D1
ATDT=1234
ATVB=12300
UPTIME=120
OSERR=0
PRX=1295
PTX=7933
[an ASCII ETX character, 03]
```

The first character is a Start of Text character. This is followed by the phrase "BEGIN STATUS". Each line in the status transmission is terminated with an ASCII carriage return (0D) and line feed (0A).

As new features are added to the fireline, there may be new status lines added, but all FireLine modems with Revision D or higher firmware support at a minimum, the above shown status parameters. The status transmission will end with an ASCII 0 character, the End of Text character.

The parameters passed in the status message are:

- ATMY** The ID of the modem sending the status.
- ATVR** The firmware version in the modem
- ATDT** The ID the modem is programmed to send data to.
- ATVB** DC voltage, in millivolts of the DC input to the modem.
- UPTIME** Number of seconds since this modem has turned on.
- OSERR** The number of Operatin System Errors. Normally this is 0.

PRX The number of packets this modem has received.

PTX The number of packets this modem has transmitted.

The ID code that the status information is sent to, is set with the **ATMA xxxx** command. Whenever a status transmission is sent, the "TO ID" of the transmission is the address set using the **ATMA** command. This allows the system to be configured in a way the normal modem communications take place between the modems, and the status information only is delivered to modems that need to receive it.

10. Tune-up and Alignment

Do not key the transmitter for more than 30 seconds out of every 300 seconds. The transmitter is rated at 10% duty cycle maximum.

Radio calibration and alignment is performed using the **ATR_x** commands. The *FireLine* modem has been factory calibrated, in should not require any re-calibration when installed, or when changing frequency or channel. Unless the user is trained in radio test and calibration, the values stored in the R registers should not be modified.

Improper adjustment of the radio calibration (R0-R9 and RA registers), can result in failure of the radio modem.

Calibration and alignment values are stored internal to the modem in the “R” registers. (R0-R9 and RA). For example, to read R8, issue the **ATR8** command without any parameter. To change the setting, issue the **ATR8 nn** command, where nn is the new value you would like to store.

Once you read a register using an ATR_x command, you may modify its value by entering a “U” for up or a “D” for down. U or D will change the value by one. Use this trick carefully, because it modifies the last R register that was read, and it is easy to unintentionally modify the wrong register.

10.1. Periodic Calibration

The only setting that may require adjustment is the center frequency. After years of operation, all crystals will age and change frequency slightly. The ATR8 command is used to adjust the center frequency. Like all narrow-band radios, semi-annual checks and adjustment of frequency is recommended.

10.2. Radio Module Types

The following table lists the parameters in the modem that are calibrated at the factory. Calibration values are stored in registers R0 – R9. The *FireLine* radio modem has the capability of incorporating a variety of different radios modules. Each different radio model is considered a different “radio type”. The radio type is read and set with the **ATRT** command.

Typical Register Settings for Various Radio Modules

R Register	FireLine Model	R0	R5	R8	R9
Function		Peak Deviation	Preamble Length	Frequency Offset	Modulation Balance
Radio Type 2 (DM3473 Module)	RV-M5-Ux-N2 RV-M5-Ux-W2	100	5	0	20
Radio Type 3 (DM3475 Module)		120	5	0	20
Radio Type 5 (DM3472 Module)	RV-M5-Ux-S2	175	9	50	NA

The type of radio module installed in the radio is shown on the serial number label attached to the *FireLine* modem's rear cover.

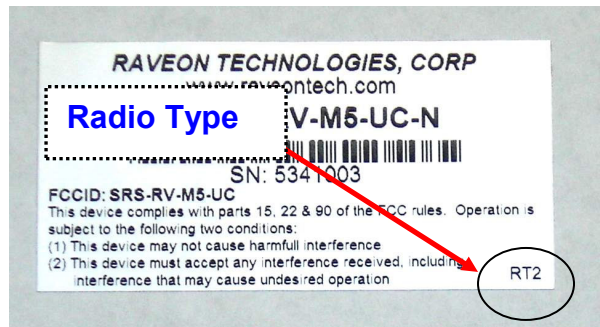

10.3. Center Frequency

1. Key the transmitter with CW output using this command:
ATTD 7
2. The modem will now put out CW on the center of the channel.
3. Read the frequency offset with the **ATR8** command.
4. Adjust the frequency to the center of the channel with the **ATR8** command. You can use the “U” key and the “D” key to change the settings up and down one value in real time.

10.4. TX Deviation

1. Switch to channel 1.
2. Key the transmitter into a 50 ohm load using the **ATTD 5** command. The unit will now transmit, and send a digital 0 continuously. This should be +2.0kHz in frequency for narrow-band radios (12.5kHz spaced channels) and +4.0kHz for wide-band (25kHz channels).
3. Adjust the deviation register setting so that the frequency deviation is correct. The deviation is set with a digital adjustment. Use the **ATRO** command to read or set the deviation level.

10.5. TX Modulation Balance

(Note: This step is not performed on radios with Radio Type 5)

1. Set-up a service monitor to monitor the FM deviation of the transmitted signal on an oscilloscope. The frequency response of the demodulated FM signal must be greater than 10Hz to 5kHz without any de-emphasis.
2. Transmit random data with the *FireLine*, using the **ATDT 1** command. This command will cause the *FireLine* to automatically key up, and send random data for one minute.

3. Verify the DC center of the demodulated data is stable. The random data should be randomly timed 1s and 0s, and have little to no AC component on them. See pictures below for details.
4. If necessary, change the **ATR9** setting so that the long data bit have the same amplitude and DC value as the shorter ones.

10.6. RX DC Offset Verification

To verify that the DC center of the received signal is near the nominal value, perform the following steps:

1. Generate a test signal, 1kHz tone, 1.5kHz deviation, on the receive frequency. Connect the signal generator to the antenna input. Set the RF level to -90dBm.
2. Measure the average voltage at TPRX1 on the modem circuit board.
3. The DC voltage should be between 1.0 and 2.0 volts, and the p-p voltage of the sine wave should be greater than 50mV and the DC bias on the signal should be less than 2 volts DC.
4. There is no calibration required in this step, but if the specification is not meet, the “quad” coil in the radio may need adjustment to pull the DC level into spec.

10.7. RX Carrier Detect

The DCD signal from the modem may be generated by detection of RF, using an internal signal called RSSI (Receive Signal Strength Indication). The RSSI signal is an analog signal representing the strength of the RF carrier. It is compared with a pre-set value, and if it is above this value, Carrier Detect is asserted. The pre-set value may be change with the **ATRA** command.

When the modem is used in the Streaming Mode (non-packetized operation, you may wish to configure the modem to require RF carrier detect to be active for the modem to receive data. Use the **ATRF** command to enable/disable this feature.

To set the RF carrier detect level, perform the following steps:

1. Generate a test signal, 1kHz tone, 1.5kHz deviation, on the receive frequency. Connect the signal generator to the antenna input. Turn the RF level off.
2. Watch the RSSI DAC value by issuing the **AT\$5** command. The current reading will be sent out the serial port.
3. Adjust the RF level to a point where you would like the RSSI to trigger the CD signal. This is factory-set to -110dBm.
4. Send the **ATRA nnn** command. Set **nnn** to be equal to the RSSI setting you would like the CD signal to trip at. The BUSY LED will also indicate an RF

carrier when the RF carrier is above the threshold set with the ATRA command.

5. Generate an RF signal on-channel with a level of -110dBm. Verify the Power/BUSY LED stays on. If it does not, repeat step 4, adjusting in increments of 10.

10.8. MURS Operation

When this product is used on frequencies governed by the FCC rules part 95, Subpart J, (Multiple Use Radio Service operation), it must be configured using the special MURS command. When in the command mode, enter the command **MURS 1**. This programs all channels to the MURS channels, and locks-out the ability to re-program the channels to any other frequency. The MURS channels are:

1	151.820 MHz
2	151.880 MHz
3	151.940 MHz
4	154.570 MHz
5	154.600 MHz
6	151.820 MHz

11. SkyLine Compatibility

11.1. General

The *FireLine* RF modem has built-in compatibility with a radio modem made by Sonik Technologies, Vytex Wireless, and Cal Amp called the *SkyLine*. In most applications, Raveon's *FireLine* modem can communicate with *SkyLine* modems, provided the *FireLine* is properly configured. There are two versions of the *Skyline*, a wide-band version running at 9600 bps over the air, and a narrow-band version running at 5142bps over the air.

11.2. Configuring FireLine to Communicate with a SkyLine

To configure the *FireLine* modem to talk to an old *SkyLine* modem, the user must configure the *FireLine* with these commands:

- ATR2 7** This command tells the *FireLine* modem to operate with an over-the-air baud rate of 5124 bits per second. This is the baud-rate of all narrow-band (12.5Khz spaced) *SkyLine* radio modems. Wide-band *SkyLine* radios operated at 9600 baud over the air. The command to set the *FireLine* to 9600 baud over the air is **ATR2 5**.
- ATR5 8** This command tells the *FireLine* modem to send 8 bytes of pre-amble before every transmission.
- MYID 1234** The MYID of the *FireLine* modem is set with the **ATMY** command or the MYID command. The default MYID of the *SkyLine* was 1234.
- TOID FFFF** The TOID of the *FireLine* modem is set with the **ATDT** command or the TOID command. The default TOID of the *SkyLine* was FFFF (broadcast address).

A quick-configure command is included in the *FireLine*, to allow it to be easily switch to the *FireLine* mode. The command is "**SKYLINE**". When in the configuration mode, enter **SKYLINE**, and the modem will reconfigure itself as a narrow-band *SkyLine* modem, with **TOID = FFFF**, **MYID=1234**, 80 byte packets, 20mS serial port time out, channel 1 frequency, over-the-air baud rate 5142.

11.3. Use of the DM3472 Wide-band Module

The *FireLine* modem may be configured with a DM3472 wide-band radio module to communicate with the Sonik SL-UC wide-band *SkyLine* radio modem at 9600bps. To do so, the following parameters must be set. All other configurations will stay the same as a standard *FireLine*.

The *FireLine* radio modem must be a wideband configuration, with a -S on the end of the part number. (ie RV-M5-UC-S2)

Note: This requires that the radio type be changed to 5, and the peak deviation set to 3.0 kHz.

- ATRT 5** Set the radio type to 5. This must be the first parameter that is configured.
- SKYLINE** Set the *SkyLine* protocol mode.

- ATR2 5** Set the over-the-air baud rate to 9600 baud.
- ATR0 180** Set the peak deviation to +/-3.0kHz. This setting will probably have to adjusted to achieve the exact deviation.
- ATR1 1** Use data CD
- ATR5 9** SkyLine wide-band modems required 9 bytes of preamble.

12. Antenna Information

Key to a successful installation is the choice and installation of a good antenna system. A good quality antenna can more than double the range of a radio system. Properly locating the antenna is vital to creating a quality radio link, and a poor installation can decrease the range of the system by as much as 90%.

Use these guidelines to evaluate your antenna system design, and be sure contact a quality radio communication equipment distributor such as *Talley Electronics* (<http://www.talleycom.com>) to help choose the proper antenna for your system.

To increase your communications range, located the antenna high as needed, practical, safe, and allowed by your license. On fixed base-station applications, you may utilize an antenna with gain. *Note: The maximum Permissible Exposure (MPE) for this product was computed using a 0dB gain antenna, and must be recalculated if a gain antenna is used.*

Height

Try to locate the antenna as high above obstructions, vehicle, and buildings as possible. UHF radio channels require a clear “line-of-sight” between the transmitter and the receiver. Radio waves will penetrate buildings, and reflect off and around obstacles, but the fewer obstacles between stations the better the signal quality.

Gain

Antennas are specified by their gain. They actually do not have gain, but rather they can increase the strength of a signal in certain directions, at the expense of attenuating signals from other directions. Gain antennas always have “patterns” of gain. It is important you understand the pattern of your antenna. Omni directional antennas will receive from almost any angle, 360 degrees around them.



Omnidirectional Antenna



Directional Antenna

13. Internal Radio Connection

Internal to the *FireLine*, the modem circuit board interfaces to a radio transceiver module via a 14 pin single in-line connector. The following table describes the function of each pin.

Pin #	Function
1	System ground
2	+7.5V regulated output, $\pm 5\%$. 1.5amp maximum current source.
3	+7.5V transmit, $\pm 5\%$. 100mA maximum current source.
4	RX ON. +5.0V in RX mode 0V TX mode. 10mA maximum current source.
5	Radio ON. +5.0V DC to radio. Digital output. 10mA maximum current source.
6	Transmit modulation. 2.5V DC RX, 2.5V DC with 2V p-p Gaussian filtered 9600bps data during transmit.
7	Synthesizer lock detect input. Low=unlocked. High = locked.
8	PLL enable signal. Latch enable signal for serial interface to PLL.
9	PLL data signal. Data to PLL chip via three wire interface, pins 8,9, and 10.
10	PLL clock for three wire interface.
11	No connect
12	RSSI input from radio. Optional input signal.
13	Receiver discriminator input from radio. On-board AGC for signals with amplitude of .1V-2Vp-p and a DC bias of 1V-2.5V.
14	Modulation balance output. Adjustable DC voltage, set with the ATR9 command.

14. Appendix A. Serial Port Hardware

14.1. Serial Port Data and Handshaking Signals

In computer terminology, the RF modem is considered a “Data Communications Equipment” device, or DCE. The user’s hardware that the modem is connected to is considered “Data Terminal Equipment”, or DTE.

Following is a description of how data and control is communicated over the various serial port signals between the modem (DCE) and another device (DTE) that the modem’s I/O port is connected to.

TxD (INPUT)

This line is used to transmit data from the DTE to the DCE. It is maintained at a logical 1 state when nothing is transmitted. If Hardware Flow Control is enabled in the modem, the terminal will start to transmit data to the modem when a logical 1 is present on all of the following lines:

- Clear To Send (output from modem)
- Request to Send (output from the DTE)

RxD (OUTPUT)

This circuit is used to receive data from the DCE to the DTE. The modem will start to transmit data to the DTE when a logical 1 is present on all of the following lines:

- Data Terminal Ready (reply that it is OK to send)
- Data Set Ready (asserted by the modem)

RTS

On this line, the DTE will send a signal when it wants to receive data from the *FireLine* modem. The *FireLine* modem will not output data unless this pin is low, or “Flow Control” has been disabled in the modem set-up. When a DTE (such as a PC or microcontroller) wants to stop the flow into it, it negates RTS. Negated “Request To Send” (digital 1) means “request NOT to send to me” (stop sending). When the DTE is ready for more bytes it asserts RTS (digital 0) and the flow of bytes to it resumes. DCE equipment works the same way but sends the stop signal out the CTS pin. Thus it’s RTS/CTS flow control using 2 lines. The user may turn this feature off or on, using the **ATCH** command. The default is OFF. To turn it on, issue an **ATCH 1** command.

CTS

This signal is an output from the *FireLine*, and it indicates the *FireLine*’s ability to send more data. If the user tries to send more data into the *FireLine* than the *FireLine* can transmit over the air, it will negate the signal on this pin. The CTS may be asserted when the serial-port data rate is greater to or equal to the over-the-air rate. For example, if the over-the-air data rate is set to 2400 baud, and

the user is send data into the modem at 9600 baud, the modem will negate the CTS signal once the *FireLine*'s internal data buffers become full.

CD

On this line the modem indicates to the DTE that it has received a carrier from a remote device. It will assert this signal any time there is a carrier detected. The modem may be configured to assert this when an RF carrier is detected (any on-channel RF, voice or data), assert it only when another RF modem signal is detected, or always assert it. The operation of this line is configured with the ATR1 command. The default is 1 (asserts when *FireLine* data is detected on the radio receiver).

DTR

This line is an input to the *FireLine*. It is normally ignored because the default configuration of the *FireLine* modem is to ignore this signal. If the DTR line is enabled for use, using the **ATK5 1** command, the DTR input line can be used to put the *FireLine* modem into its SLEEP mode. With DTR enabled, anytime the DTR line is a logic 0, the *FireLine* will be operating normally. With DTR enabled, anytime the DTR line is a logic 1, the *FireLine* will go into a SLEEP mode, drawing much less DC power.

14.2. Null modem without handshaking

Sometimes, a “Null Modem” cable may be required to connect the *FireLine* modem to another device. The specific connections are very dependent upon the type of hardware and handshaking used, but the following sections should help in configuring a null-modem cable.

How to use the handshaking lines in a null modem configuration? The simplest way is to don't use them at all. In that situation, only the data lines and signal ground are cross connected in the null modem communication cable. All other pins have no connection. An example of such a null modem cable without handshaking can be seen in the figure below.

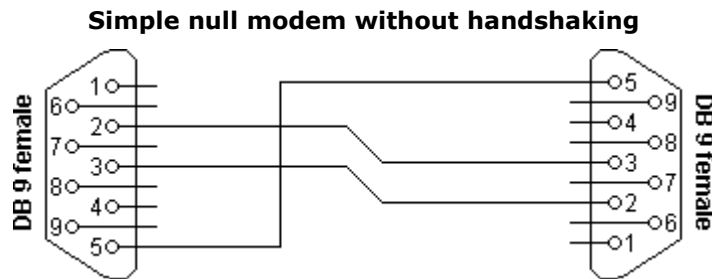

(DB-9 Female shown. Same wiring for male-to-male cable)

Connector 1	Connector 2	Function
2	3	Rx ← Tx
3	2	Tx → Rx
5	5	Signal ground

14.3. Compatibility issues

There is a problem, if either of the two devices checks the **DSR** or **CD** inputs. These signals normally define the ability of the other side to communicate. As they are not connected, their signal level will never go high. This might cause a problem.

The same holds for the **RTS/CTS** handshaking sequence. If the software on both sides is well structured, the **RTS** output is set high and then a waiting cycle is started until a ready signal is received on the **CTS** line. This causes the software to hang because no physical connection is present to either **CTS** line to make this possible. The only type of communication which is allowed on such a null modem line is data-only traffic on the cross connected **Rx/Tx** lines.

14.4. Null modem with full handshaking

In this null modem cable, seven wires are present. The cable is shown in the following figure.

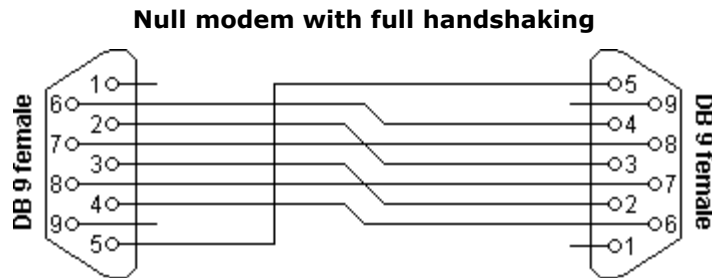

(DB-9 Female shown. Same wiring for male-to-male cable)

Connector 1	Connector 2	Function		
2	3	Rx	←	Tx
3	2	Tx	→	Rx
4	6	DTR	→	DSR
5	5	Signal ground		
6	4	DSR	←	DTR
7	8	RTS	→	CTS
8	7	CTS	←	RTS

14.5. Compatibility issues

The null modem cable with full handshaking does not permit the older way of flow control to take place. The main incompatibility is the cross connection of the **RTS** and **CTS** pins. Originally, these pins are used for a question/answer type of flow control. When the full handshaking null modem cable is used, there is no request anymore. The lines are purely used for telling the other side if communication is possible.

The main advantage of this cable is, that there are two signaling lines in each direction. Both the **RTS** and **DTR** outputs can be used to send flow control information to the other device. This makes it possible to achieve high communication speeds with this type of null modem cable, provided that the system has been designed for it.

15. Troubleshooting

Symptom: Unit will not receive

Solution #1. Verify that the modem is on the correct RF channel. If it is, the RX LED should blink every time another modem tries to transmit to it. If the RX LED does not blink when it should be receiving, it is on the wrong RF frequency.

Solution #2. If the addresses match, and RX LED blinks but still no reception of data, verify that the RTS signal is asserted. The *FireLine* will not output data if the RTS signal on the DB-9 I/O connector is not asserted. If the user's hardware cannot assert the RTS hardware line, disable hardware flow control in the *FireLine* modem, using the **ATCH 0** command.

Solution #3. If the RX LED blinks, verify that the Unit Address of the sending modem matches the unit address of the receiving modem. If this is OK, verify that the over-the-air baud rate of all modems is the same (ATR2 command).

Solution #4. Verify Low Power Mode. The *FireLine* has an optional Low Power Mode (LPM). If LPM is enabled, the *FireLine* will power down whenever the DTR line of the serial port is turned off. The Power LED will blink once every 10 seconds in the LPM mode. The **ATRP** command is used to set or read the Low Power Mode. **ATRP 1** enables it, and **ATRP 0** disables it. If LPM is used (**ATRP 1**), then the *FireLine* will turn off when the DTR line is off, or the program connected to the serial port is closed, or the RS-232 connector is unplugged.

Symptom: Unit will not transmit

Solution #1. Verify that CTS is wired. Some devices that could be connected to the *FireLine* will require the CTS signal to be asserted. The *FireLine* does assert this signal, but if the wire is not connected, your device may not be outputting data to the *FireLine*. If the TX LED blinks, the *FireLine* is transmitting data. Every time data enters the modem, the TX LED should blink.

Solution #2. Verify that serial port timeout is OK. The ATG0 command sets the number of microseconds that the *FireLine* will look for in the serial input data stream. If a pause greater than this value happens, the modem will transmit. If the ATG0 parameter is set very large, say 2000000, this means 2 seconds, and the modem may simply be waiting a long time.

Solution #3. Verify that the radio channel is clear or BCL is off. The **ATBC 1** command enables Busy Channel Lockout. If BCL is on, the modem will not transmit on a busy channel. The **ATBC 0** command turns it off, and thus the modem will transmit when it needs to, regardless if the channel is busy. The RX led on the front of the modem is illuminated whenever the radio channel is busy (RF present).

Solution #4. Verify Low Power Mode. The *FireLine* has an optional Low Power Mode (LPM). If LPM is enabled, the *FireLine* will power down whenever the DTR line of the serial port is turned off. The Power LED will blink once every 10 seconds in the LPM mode. The **ATRP** command is used to set or read the Low Power Mode. **ATRP 1** enables it, and **ATRP 0** disables it. If LPM is used (**ATRP 1**), then the *FireLine* will turn off when the DTR line is off, or the program connected to the serial port is closed, or the RS-232 connector is unplugged.

Symptom: Receive light blinks, but no data is received

Solution #1. Verify Input/Output Configuration. The *FireLine* has numerous I/O options. RS232 is standard, but Ethernet, RS485 or RS422 may be configured also. Use the ATIO command to view how the I/O is configured. ATIO 0 is the default (RS232 mode).

Solution #2. Verify the serial port baud rate. This is difficult if it is set wrong, because you cannot enter the command mode to check it. Try all possible baud rates, and see if one of them works with the modem. Alternately, remove the rear cover of the modem, and press the CONFIG button. This will force the modem into the Command Mode, as well as set the serial port to 9600.

baud, 8 data bits, one stop, and no parity. If the baud-rate was OK, verify the AT, BT and CT times, that they are long enough for you to enter the +++ string.

Symptom: Long delay before transmitting

Solution #1. Verify that serial port timeout is OK. The ATR3 command sets the number of milliseconds that the FireLine will look for in the serial input data stream. If a pause greater than this value happens, the modem will transmit. If the ATG0 parameter is set very large, say 2000, this means 2 seconds, and the modem may simply be waiting a long time. Typical settings for this parameter are 20 (20mS).

Symptom: Modified parameters are lost at power-up

Solution #1. Issue an ATSV command. After any parameter is modified, the modem will operate with the new setting, but unless the ATSV command is issued, it will revert to the old setting upon turning power off and back on again. The ATSV command saves all parameters into EEPROM memory, and these saved parameters are restored upon power up.

Symptom: Cannot enter Command Mode

Solution #1. Verify the serial port baud rate. This is difficult if it is set wrong, because you cannot enter the command mode to check it. Try all possible baud rates, and see if one of them works with the modem. Alternately, remove the rear cover of the modem, and press the CONFIG button. This will force the modem into the Command Mode, as well as set the serial port to 9600 baud, 8 data bits, one stop, and no parity. If the baud-rate was OK, verify the AT, BT and CT times, that they are long enough for you to enter the +++ string.

Solution #2. Handshaking. You may have hardware handshaking enabled on your terminal program, but the hardware or cable may not support it. Disable hardware handshaking on your terminal program to verify this is the issue.

Symptom: Modem appears dead.

Solution #1. Verify the power is on. When the modem has good DC power, the PWR LED will blink once per second. If it is not blinking, either the modem does not have power, the modem is broken, or the LEDs have been disabled via the **ATL0** command.

Solution #2. Verify Low Power Mode. The FireLine has an optional Low Power Mode (LPM). If LPM is enabled, the FireLine will power down whenever the DTR line of the serial port is turned off. The Power LED will blink once every 10 seconds in the LPM mode. The **ATRP** command is used to set or read the Low Power Mode. **ATRP 1** enables it, and **ATRP 0** disables it. If LPM is used (**ATRP 1**), then the FireLine will turn off when the DTR line is off, or the program connected to the serial port is closed, or the RS-232 connector is unplugged.

16. Mechanical

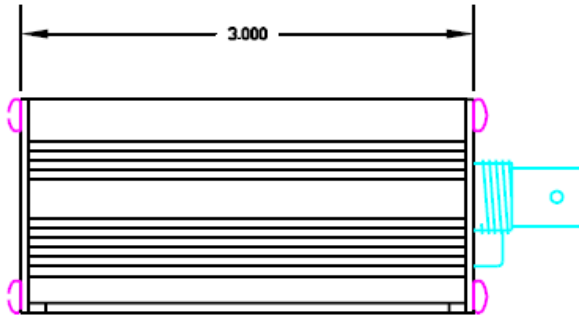
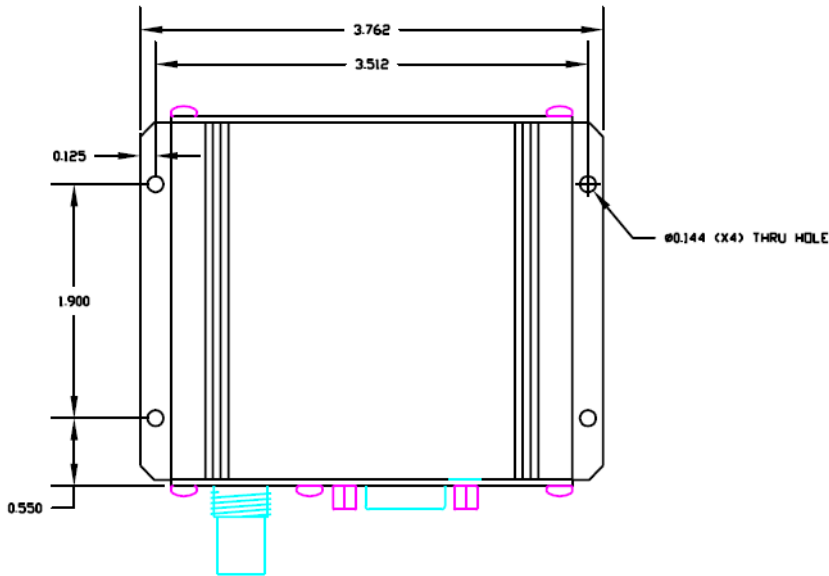
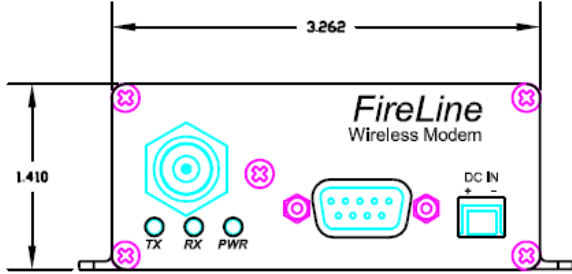

17. Use with External Radio

17.1. Overview

The model RV-M5-X is an OEM version of the FireLine modem which does not contain an internal radio.

17.2. Radio Requirements

The radio used with the RV-M5-X modem must be capable of:

- A) Flat transmit modulation. The frequency response of the the transmit audio must be DC to at least 2.5kHz (for 4800baud) or DC to 4.8kHz (for 9600 baud).
- B) Flat receive audio. The audio output must have a flat frequency response. Often this is called “Discriminator Output”. Speaker output or any receive audio source that is de-emphasized will not work. The receive audio must be flat from DC to at least 2.5kHz (for 4800baud) or DC to 4.8kHz (for 9600 baud).
- C) Fast PLL. The TX attack time of the transmitter must be 10mS or less. If the transmitter transmit attack time is slower than 10mS, then additional preamble bytes should be sent to accommodate for the slow rise time. The **ATR5** command sets the number of transmit pre-amble bytes.

On the rear panel of the RV-M5-X is a 15 pin D-sub female connector, intended for connection to an external radio. The following table describes the functions of the various pins.

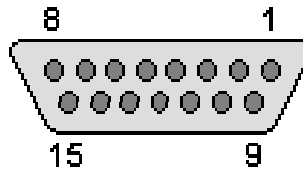

17.3. Radio Interface Connector Pin-Out

Front view of 15 D female Radio Interface Connector. It is wired 1-to-1 to the radio interface connector on the modem PCB.

Pin Number	Function	Notes
1	Ground	Ground connection
2	8V DC Out	8V DC output. 2A max at 10% duty, 1A max at 25% duty, 250mA max continuous.
3	TX ON	Active high. 0V when off or in RX mode. 5V in TX mode. Digital output from modem. 10mA max current draw.
4	RX ON	Active high. 0V when off or in TX mode. 5V in RX mode. Digital output from modem. 10mA max current draw.
5	Radio ON.	Active high. 0V when external radio should be off. 5V when external radio should be on. Digital output from modem. 10mA max current draw.
6	TX Mod	Wide-band modulation to the transmitter. Must be DC coupled,

		flat 0-4800Hz frequency response. 1V p-p nominal for full deviation.
7	<i>No Connect</i>	
8	<i>No Connect</i>	
9	<i>No Connect</i>	
10	<i>No Connect</i>	
11	<i>Keyline</i>	In RX mode, this is an open-drain circuit. In TX mode, it is pulled to ground with approximately a 10 ohm impedance.
12	<i>RSSI In</i>	Optional signal. Analog RSSI from external radio to the FireLine modem. Unused in most applications. May be used as signal BUSY Channel to the modem. High-busy, low=not busy.
13	<i>RX Audio</i>	Wide-band receive audio input. Must be DC coupled to the radio FM discriminator. Flat response from 0 to 4800Hz. Signal must be analog, between .5 and 2.5V DC.
14	<i>No Connect</i>	
15	<i>DC Input to modem. Do not draw current.</i>	9-16VDC. Directly connected to the DC input jack of the FireLine. Use to power the FireLine modem. DO not power an external radio from this signal.

17.4. Connections

DC Power

Connect 12.5V DC to the RV-M5-X's DC power input connector on the front-panel of the RV-M5.

Connect the external radio to its DC power source using its own DC power cable. Note, many radios draw many amps of power, and the power source must be capable of supplying adequate amperage.

Ground (1)

Be sure the ground connection on the modem (pin 1) and the radio's signal ground are well connected.

Transmit Signal (optional) (3)

Pin 3 of the radio interface connector is the alternate transmit keyline. It will go to 5volts whenever the transmitter should be on. It will be low (near 0V), when the external radio should be in receive mode.

If the external radio requires a low signal to key the transmitter, do not use this signal. Use the following "KeyLine" line instead, pin 11.

Receiver Enable (optional) (4)

This output will go high when the unit is to be in receive mode, and low when transmitting.

KeyLine Signal (1)

Pin 11 of the radio interface connector is the primary transmit keyline. It will go to ground whenever the transmitter should be on. It will be high or floating when the external radio should be the receive mode.

Receive Audio into the modem (13)

Connect the receiver's FM discriminator output to this input. Do not connect this to the speaker audio.

Transmit Modulation out of the modem (6)

Connect this audio output to the radio's transmit audio input. It must be DC coupled to the radio's modulator (no series capacitors). There is a 1.65V DC bias on this line, and the transmit audio modulation level is adjustable with the **ATR0** command.

RSSI Input (12)

If the external radio has an analog RSSI signal strength indication, connect it to the RSSI input if you wish to use RSSI as a qualifier for reception. In most cases this is not necessary, but if the modem is configured to prohibit transmission on busy channels, the RSSI must be connected and calibrated so that the modem can check for busy channel.

17.5. Calibration

Once the modem is connected, perform the radio alignment steps as described in Section 10.

The default radio settings are the same as the standard RV-M5-UC. The over-the-air baud rate is 4800 baud.

17.6. Internal Cable

Internal to the RV-M5-X is a cable that connect the 15D to the 5A110PCA. It is wired as follows.

15D Pin Number	Function	Connection to 5A110 PCA
1	<i>Ground</i>	1
2	<i>8V DC Out</i>	2
3	<i>TX ON</i>	3 (see sect 17.7)
4	<i>RX ON</i>	4
5	<i>Radio ON.</i>	5
6	<i>TX Mod</i>	6
7	<i>No Connect</i>	
8	<i>No Connect</i>	
9	<i>No Connect</i>	
10	<i>No Connect</i>	
11	<i>Keyline</i>	14 (which is jumpered on the PCA to Q2 drain)

12	<i>RSSI In</i>	12
13	<i>RX Audio</i>	13
14	<i>No Connect</i>	-
15	<i>DC Input to modem. Do not draw current.</i>	J1 pin 2

17.7. Factory Mods to 5A110PCB for External Radio Use

These changes are done internally to the PCA inside the FireLine modem to accommodate the use of an external radio.

1. Remove Q1 and C67. Place R63 as 10 ohm jumper. These changes cause pin 3 to have a 0/5V control signal on it. Standard is 0/8V for TX on.
2. Remove R23. Jumper Q2 drain to pin 14.

Limited One Year Warranty

If within one year from date of purchase, this product fails due to a defect in material or workmanship, Raveon Technologies, Incorporated will repair or replace it, at Raveon's sole discretion. This warranty is extended to the original consumer purchaser only and is not transferable.

This warranty does not apply to: (a) product damage caused by accident, dropping or abuse in handling, acts of God or any negligent use; (b) units which have been subject to unauthorized repair, opened, taken apart or otherwise modified; (c) units not used in accordance with instructions; (d) damages exceeding the cost of the product; (e) batteries; (f) the finish on any portion of the product, such as surface and/or weathering, as this is considered normal wear and tear; (g) transit damage, initial installation costs, removal costs, or reinstallation costs; (h) damage due to lighting, floods, fire, or earthquakes.

RAVEON TECHNOLOGIES INCORPORATED WILL NOT BE LIABLE FOR INCIDENTAL OR CONSEQUENTIAL DAMAGES. SOME STATES DO NOT ALLOW THE EXCLUSION OR LIMITATION OF INCIDENTAL OR CONSEQUENTIAL DAMAGES, SO THE ABOVE LIMITATION OR EXCLUSION MAY NOT APPLY TO YOU. THIS WARRANTY IS IN LIEU OF ALL OTHER EXPRESS OR IMPLIED WARRANTIES. ALL IMPLIED WARRANTIES, INCLUDING THE WARRANTY OF MERCHANTABILITY AND THE WARRANTY OF FITNESS FOR A PARTICULAR PURPOSE, ARE HEREBY MODIFIED TO EXIST ONLY AS CONTAINED IN THIS LIMITED WARRANTY, AND SHALL BE OF THE SAME DURATION AS THE WARRANTY PERIOD STATED ABOVE. SOME STATES DO NOT ALLOW LIMITATIONS ON THE DURATION OF AN IMPLIED WARRANTY, SO THE ABOVE LIMITATION MAY NOT APPLY TO YOU.

This warranty gives you specific legal rights and you may also have other rights which vary from state to state.

Warranty service is available by mailing postage prepaid to:

*Raveon Technologies Corporation
2722 Loker Avenue West
Suite D
Carlsbad, CA 92024*

To obtain warranty service, include a copy of the original sales receipt or invoice showing the date, location, and price of purchase. Include a written description of the problem with the product, a phone number and name of person who may be contacted regarding the problem, and the address to where the product should be returned.

Products repaired under warranty will typically have their program memories erased and reset to factory default settings.